

Multi-directionally Activated Sign Support Hardware System



SSS21a-b	
SHEET NO.	DATE
1 of 3	7/29/16

INTENDED USE

The Xcessories Squared and Allied Tube & Conduit Multi-directionally Activated Sign Support Hardware System may be used in place of many sign assembly installations that would typically use beam posts. The system is unique because it contains an Xcessories Squared omni-directional slip base assembly and omni-directional hinge assembly. It is designed to hold an Allied Tube 4" x minimum 8ga solid wall square steel post. When properly installed, the clamping force of the slip base hardware holds the slip base top half to the slip base bottom half to meet or exceed the wind load capability of the sign support, while still allowing the two matching slip plates to disengage upon impact, below the maximum Change of Velocity allowed under MASH TL3 requirements. For multiple post installations, a sign post hinge assembly attaches between the bottom sign post and top sign post, just beneath the sign panel, and allows the bottom post to bend/pivot out of the way of an impacting vehicle.

Product can be used for multiple post installations (up to two in an 84 inch [2134 mm] span) when required to meet MASH TL3 break away requirements.

COMPONENTS

The Xcessories Squared and Allied Tube & Conduit Multi-directionally Activated Sign Support Hardware System consists of a triangular slip base bottom anchor, slip base match plate hardware, a triangular slip base sign post receiver, a multi-directionally activated sign hinge assembly, and sign panel bracket assemblies to hold sign panels all from Xcessories Squared, and solid wall square steel sign posts from Allied Tube & Conduit. The unibase anchor installs into a concrete footer. The bottom sign post and top sign post attaches to the sign post hinge using structural threaded bolts, washers, and nuts. Additional parts or options which have been approved are available upon request.

- A Slip Base Match Plate Hardware Set
- B Slip Base Top - Sign Post Receiver
- C Uni-Base Anchor for concrete installation
- D Multi-directionally Activated Sign Hinge Assembly
- E Sign Panel Bracket Assembly
- F Sign Post Hardware Set
- G Sign Post Cap
- H Square Sign Post

APPROVALS

FHWA Eligibility Letter SS-180 April, 15, 2016.

FHWA Eligibility Letter SS-182 February, 9, 2017.

CONTACT INFORMATION

Xcessories Squared Development & Mfg., Inc.
P.O. Box 135
Auburn, IL 62615
800-621-7948
www.x-sqrd.com

Allied Tube & Conduit
16100 South Lathrop Avenue
Harvey, IL 60426
800-882-5543
www.atkore.com

Multi-directionally Activated Sign Support Hardware System

SSS21a-b

SHEET NO.

DATE

2 of 3

2/9/17



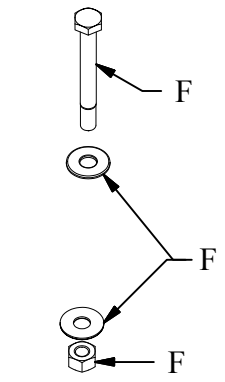
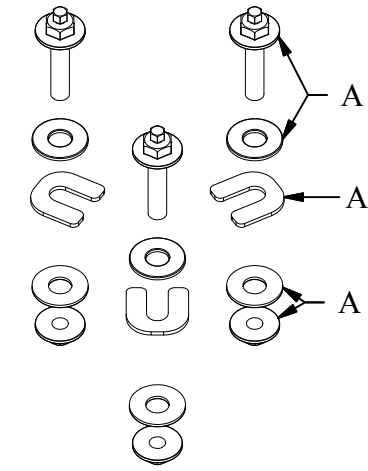
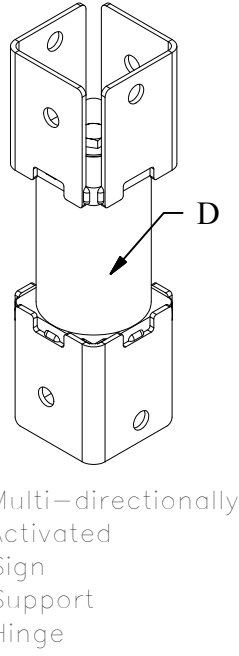
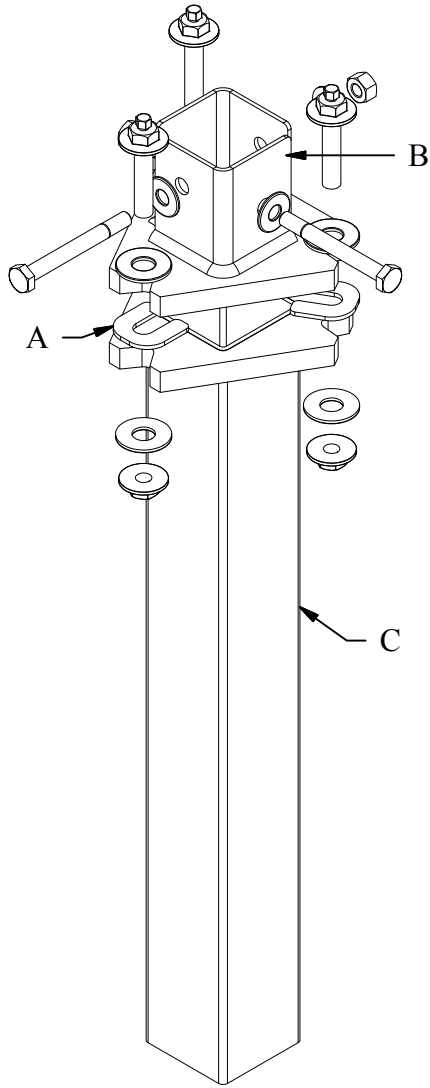
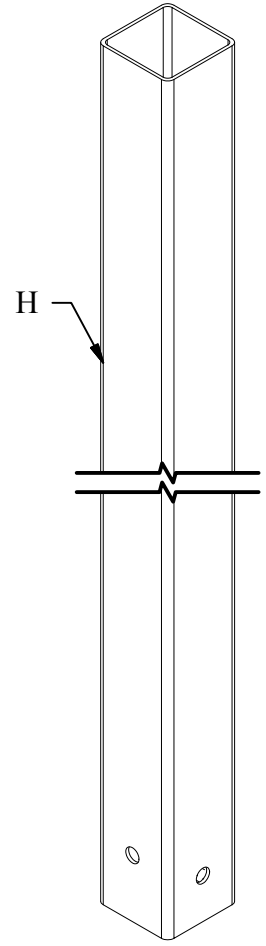
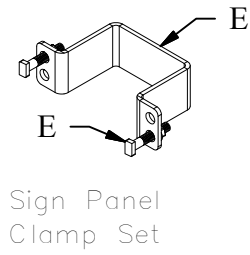
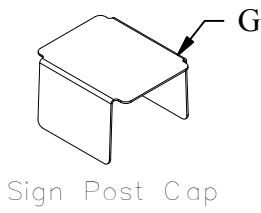

Multi-directionally Activated Sign Support Hardware System



SSS21a-b	
SHEET NO.	DATE
3 of 3	7/29/16