

Evaluation and Design of ODOT's Type 5 Guardrail with Tubular Backup

Draft Final Report

Chuck A. Plaxico, Ph.D.
James C. Kennedy, Jr., Ph.D.
Charles R. Miele, P.E.



for the
Ohio Department of Transportation
Office of Research and Development

State Job Number *PS-04-10*

November 3, 2005

Battelle
The Business of Innovation



CREDIT AND DISCLAIMER

Prepared in cooperation with the Ohio Department of Transportation and the U.S. Department of Transportation, Federal Highway Administration.

The contents of this report reflect the views of the authors who are responsible for the facts and the accuracy of the data presented herein. The contents do not necessarily reflect the official views or policies of the Ohio Department of Transportation or the Federal Highway Administration. This report does not constitute a standard, specification or regulation.

ACKNOWLEDGMENTS

This project was sponsored by the Ohio Department of Transportation. The authors gratefully acknowledge Mr. Dean Focke for his active participation and guidance throughout the project. The authors are also grateful to Roger Bligh from the Texas Transportation Institute for providing Battelle the revised model of the Geo Metro which was used in this study and a number of full-scale crash test reports and videos.

**Ohio Department of Transportation
ODOT Agreement No. 20372**

**EVALUATION AND DESIGN OF
ODOT'S TYPE 5 GUARDRAIL WITH TUBULAR BACKUP**

Project No. PS-04-10

**Draft Final Report
November 3, 2005**

Submitted to the
Ohio Department of Transportation
1980 West Broad Street
Columbus, OH 43223

Submitted by
Chuck A. Plaxico
Sr. Research Scientist

James C. Kennedy, Jr.
Associate Manager

Charles R. Miele
Principal Research Scientist

Battelle
The Business of Innovation
**505 King Avenue
Columbus, OH 43201**

EVALUATION AND DESIGN OF ODOT'S TYPE 5 GUARDRAIL WITH TUBULAR BACKUP

Chuck A. Plaxico, Ph.D., Sr. Research Scientist
James C. Kennedy, Jr., Ph.D., Associate Manager
Charles R. Miele, P.E., Principal Research Engineer

Battelle Memorial Institute
505 King Avenue
Columbus, OH 43201

ABSTRACT

The purpose of this project was to assess the performance of both the ODOT GR-2.2 guardrail and the ODOT GR-3.4 transition system under NCHRP Report 350 test level 3 (TL-3) conditions, propose any modifications that would improve their crashworthiness and, ultimately, ensure that the final designs qualify for use on the National Highway System (NHS) as TL-3 systems.

Finite element analyses of the guardrail and transition system were performed using the LS-DYNA finite element software to simulate NCHRP Report 350 Test 3-10 and Test 3-11 impact scenarios. The analysis results indicated that the original ODOT GR-2.2 guardrail would successfully meet all NCHRP Report 350 test level 3 safety criteria. The analyses also indicated, however, that the performance of the system could be significantly improved with simple modifications to the guardrail.

Based on the results of this study, the original GR-2.2 design and several improved designs have been accepted by the FHWA as NCHRP Report 350 TL-3 systems and may be used on the National Highway System at the state's discretion. Further, the results of the study indicated that the integrated system of the Nested Type 5 Guardrail with Tubular Backup and the ODOT GR-3.4 transition would provide significant improvement in crashworthy performance in comparison with the original design and was therefore recommended as a final design.

KEYWORDS

Guardrail, Guardrail Transition, ODOT GR-2.2, ODOT GR-3.4, Culvert Barrier, Finite Element Analysis, NCHRP Report 350, Test 3-11, Test 3-10

TABLE OF CONTENTS

CREDIT AND DISCLAIMER	3
ACKNOWLEDGMENTS	3
ABSTRACT	5
KEYWORDS	5
LIST OF FIGURES	8
INTRODUCTION	11
RESEARCH OBJECTIVES	13
RESEARCH APPROACH	14
PHASE I	15
Analysis Criteria	15
Guardrail Mounting Options	16
PHASE II	17
PHASE III	17
PHASE I – EVALUATION AND REDESIGN OF THE ODOT GR-2.2 GUARDRAIL	18
MODEL DEVELOPMENT	18
C2500 Vehicle Model	18
820C Vehicle Model	18
ODOT GR-2.2 Guardrail Model	19
ANALYSIS OF THE ODOT GR-2.2 GUARDRAIL	21
Guardrail Posts in Concrete Foundation – Test 3-10	21
Guardrail Posts in Concrete Foundation – Test 3-11	25
Guardrail Posts in Soil Foundation – Test 3-11	28
Summary of ODOT GR-2.2 Analysis	31
IMPROVMENTS TO THE ODOT GR-2.2 GUARDRAIL	31
Design 1: Two-Tube Tubular Backup System	33
Design 2: Rub-Rail Retrofit	43
Design 3: Nested W-Beam Retrofit	48
Summary of Design Modification Results	55
PHASE II - EVALUATION AND REDESIGN OF THE ODOT GR-3.4 TRANSITION	56
ANALYSIS OF THE ODOT GR-3.4 TRANSITION	58
Case 1 and Case 2	60
Case 3	62
Case 4	66
Case 5	66
Case 6	69
DESIGN OF TRANSITION TO BE COMPATIBLE WITH THE GR-2.2	72
Modification A – Modified Connection with Staggered W-Beam Rails	73
Modification B – Modified GR-2.2 with Nested W-Beam Rails	77
Phase II Summary	81

PHASE III – NCHRP REPORT 350 TL-3 QUALIFICATION OF FINAL GUARDRAIL DESIGNS	83
PROJECT SUMMARY	84
EVALUATION OF ODOT GR-2.2 GUARDRAIL	84
IMPROVEMENTS TO THE ODOT GR-2.2 GUARDRAIL	84
EVALUATION OF THE COMPATIBILITY OF THE ODOT GR-3.4 TRANSITION	85
CONCLUSIONS AND RECOMMENDATIONS	88
IMPLEMENTATION PLAN	89
REFERENCES	90
APPENDIX 1 – Standard Drawings of the ODOT GR-2.2, ODOT GR-3.4 and Nested Type 5 Guardrail with Tubular Backup	
APPENDIX 2 – NCHRP Report 350 Test 3-10 Simulation (Single Slope Barrier)	
APPENDIX 3 – Analysis of ODOT GR-2.2 Guardrail (Test 3-10, Concrete Foundation)	
APPENDIX 4 – Analysis of ODOT GR-2.2 Guardrail (Test 3-11, Concrete Foundation)	
APPENDIX 5 – Analysis of ODOT GR-2.2 Guardrail (Test 3-11, Soil Foundation)	
APPENDIX 6 – Modified GR-2.2 with Two-Tube Backup Design (Test 3-11)	
APPENDIX 7 – Modified GR-2.2 with Rub-Rail Retrofit (Test 3-11)	

LIST OF FIGURES

Figure 1: Typical installation of the ODOT GR-2.2 guardrail	11
Figure 2: Cross-section view of guardrail model	20
Figure 3: Isometric view illustrating typical components of guardrail model.	20
Figure 4: ODOT GR-2.2 guardrail model with ODOT GR-3.4 transition on the upstream end	21
Figure 5: Vehicle impacts guardrail at 0.50 m downstream of post 1	22
Figure 6: Summary of analysis results for Test 3-10 on ODOT GR-2.2 guardrail with guardrail posts in concrete foundation	24
Figure 7: Vehicle impacts guardrail at 0.35 m downstream of post 1	25
Figure 8: Summary of analysis results for Test 3-11 on ODOT GR-2.2 guardrail with guardrail posts in concrete foundation	27
Figure 9: Vehicle impacts guardrail at 0.35 m downstream of post 1	28
Figure 10: Summary of analysis results for Test 3-11 on ODOT GR-2.2 guardrail with guardrail posts in soil	30
Figure 11: View from the F.E. analysis illustrating potential for tire snag on a guardrail post.	32
Figure 12: Cutaway view of the guardrail illustrating deformation of w-beam “wrapping” around tube section in Test 3-11 impact analysis.	32
Figure 13: View from the F.E. analysis illustrating the interaction of the tire with the guardrail	32
Proposed Design Modifications	33
Figure 14: Long-span guardrail across a culvert on HW 315 in Delaware, County.	33
Figure 15: Drawing of the Texas T101 bridge rail	34
Figure 16: Finite element model of the modified GR-2.2 with two-tube backup design	35
The performance of the two-tube system was analyzed for NCHRP Report 350 Test 3-11 impact conditions. Two mounting conditions for the posts were simulated: 1) full concrete embedment and 2) 3’-5” embedment in soil. The results of those analyses are summarized below.	35
Figure 17: Sequential views of the simulated Test 3-11 impact event on the GR-2.2 with two-tube backup (posts in concrete)	36
Figure 18: Comparison barrier deformation of the standard GR-2.2 design and the modified two-tube backup design.	36
Figure 19: Summary of analysis results for Test 3-11 on modified two-tube design with posts in concrete foundation	39
Figure 20: View from the F.E. analysis at maximum deflection of guardrail for the two-tube system with posts in soil	40
Figure 21: Sequential views of the simulated Test 3-11 impact event on the modified GR-2.2 with two-tube backup (posts in soil)	40
Figure 22: Summary of analysis results for Test 3-11 on modified two-tube design with posts in soil foundation	42
Figure 23: FE model of the modified ODOT GR-2.2 guardrail with rub-rail retrofit	43
Figure 24: Wheel of vehicle successfully redirected by rub-rail	44
Figure 25: Summary of analysis results for Test 3-11 on modified rub-rail retrofit with posts in concrete foundation	46
Figure 26: Wheel of vehicle successfully redirected by rub-rail	47
Figure 27: Sequential views of the simulated Test 3-11 impact event on the modified GR-2.2 with rub-rail (posts in soil)	47
Figure 28: Summary of analysis results for Test 3-11 on modified rub-rail retrofit with posts in soil foundation	51

Figure 29: Standard drawing of the ODOT GR-2.2 Guardrail (see Appendix 1 for details)	52
Figure 30: Comparison of the modified GR-2.2 with nested w-beam rails and the original GR-2.2 system, illustrating the reduced potential for snagging	52
Figure 31: Summary of analysis results for Test 3-11 on modified rub-rail retrofit with posts in soil foundation	54
Figure 32: Standard drawing of the ODOT GR-3.4 (see Appendix 1 for details)	57
Figure 33: Photo of the ODOT GR-2.2 guardrail and ODOT GR-3.4 transition at a site along HW 315 north of Columbus, Ohio.	57
Figure 34: Sequential views of the NCHRP Report 350 Test 3-11 analysis of the ODOT Bridge Terminal Assembly Type 4 and GR-2.2 Guardrail for Cases 1 and 2.	61
Figure 35 :Acceleration-time histories computed at the c.g. of the vehicle during Test 3-11 impact analysis of the ODOT Bridge Terminal Assembly Type 4 and GR-2.2 Guardrail for Case 2.	62
Figure 36 :Sequential views of the NCHRP Report 350 Test 3-11 analysis of the ODOT Bridge Terminal Assembly Type 4 and GR-2.2 Guardrail for Case 3.	64
Figure 37 :Acceleration-time histories computed at the c.g. of the vehicle during Test 3-11 impact analysis of the ODOT Bridge Terminal Assembly Type 4 and GR-2.2 Guardrail for Case 3 – Representative Case.	65
Figure 38 :Acceleration-time histories computed at the c.g. of the vehicle during Test 3-11 impact analysis of the ODOT Bridge Terminal Assembly Type 4 and GR-2.2 Guardrail for Case 3 – Conservative Case.	66
Figure 39: Sequential views of the NCHRP Report 350 Test 3-11 analysis of the ODOT Bridge Terminal Assembly Type 4 and GR-2.2 Guardrail for Case 5.	68
Figure 40: Acceleration-time histories computed at the c.g. of the vehicle during Test 3-11 impact analysis of the ODOT Bridge Terminal Assembly Type 4 and GR-2.2 Guardrail for Case 5.	69
Figure 41: Sequential views of the NCHRP Report 350 Test 3-11 analysis of the ODOT Bridge Terminal Assembly Type 4 and GR-2.2 Guardrail for Case 6.	70
Figure 42: Acceleration-time histories computed at the c.g. of the vehicle during Test 3-11 impact analysis of the ODOT Bridge Terminal Assembly Type 4 and GR-2.2 Guardrail for Case 6.	71
Figure 43: Analysis results illustrating cause of wheel snag at the splice connection of the GR-2.2 and GR-3.4.	72
Figure 44: Modified “staggered” rail GR-2.2 and GR-3.4 system to minimize stiffness discontinuity across splice connection.	73
Figure 45: Modified “staggered” rail GR-2.2 and GR-3.4 system to minimize stiffness discontinuity across splice connection.	74
Figure 46: Results of modified “staggered” rail system compared to results of original system for case 3, illustrating reduced potential for wheel snag.	75
Figure 47: Results of modified “staggered” rail system compared to results of original system for case 6, illustrating reduced potential for wheel snag.	76
Figure 48: Modified GR-2.2 guardrail with nested w-beam rails and standard GR-3.4 transition.	78
Figure 49: Modified GR-2.2 guardrail with nested w-beam rails and standard GR-3.4 transition.	78

Figure 50: Sequential views of the NCHRP Report 350 Test 3-11 analysis of the modified GR-2.2 with nested w-beam rails and standard GR-3.4 transition for impact Case B1.	Error!
Bookmark not defined.	80
Figure 51: Acceleration-time histories computed at the c.g. of the vehicle for impact Case B1 - NCHRP Report 350 Test 3-11 analysis of the modified GR-2.2 with nested w-beam rails and standard GR-3.4 transition	Error! Bookmark not defined.
81	
Figure 52: Comparison of the modified GR-2.2 with nested w-beam rails and the original GR-2.2 system, illustrating the reduced potential for snagging	Error! Bookmark not defined.
82	
Figure 53: Sequential views of the NCHRP Report 350 Test 3-11 analysis of the modified GR-2.2 with nested w-beam rails and standard GR-3.4 transition for impact Case B2.	80
Figure 54: Acceleration-time histories computed at the c.g. of the vehicle for impact Case B2 - NCHRP Report 350 Test 3-11 analysis of the modified GR-2.2 with nested w-beam rails and standard GR-3.4 transition	81
Figure 55: Modified ODOT GR-2.2 guardrail with nested w-beam rails and standard ODOT GR-3.4 transition.	87

INTRODUCTION

The Ohio Department of Transportation (ODOT) uses a somewhat generic guardrail system installed on many culverts throughout the state. The system used for this purpose employs the standard ODOT Type 5 W-beam guardrail with a Tubular Backup (ODOT GR-2.2). The guardrail system typically consists of two 13.5 ft (4.130 m) lengths of 12-gauge w-beam rails backed up with TS 8x4x3/16 inch (203x101x4.76 mm) structural tubing and supported by W6x25 steel section posts spaced 6.25 ft (1.9 m) on center. Mounting conditions for the guardrail posts vary from site to site depending on the depth of soil cover over the culvert (refer to Appendix 1 for detailed drawings). Figure 1 shows an installation of the system along a roadway in Ohio.



Figure 1: Typical installation of the ODOT GR-2.2 guardrail

District personnel like the simplicity of this guardrail design and want very much to keep it as an approved system. There are many of these culvert guardrail systems statewide and ODOT would realize cost savings if this design remained as a standard.

The ODOT GR-2.2 originated from the Ohio Box Beam Bridge Rail. Although neither system has been crash tested to determine if they qualify as NCHRP Report 350 Test Level 3 (TL-3) systems, the Ohio Box Beam Bridge Rail was successfully crash tested under NCHRP Report 230 guidelines for MSL-2, i.e.

- 1,980 lb. car impacting at 60.6 mph at 19.6 degrees
- 4,790 lb. car impacting at 60.0 mph at 25.0 degrees

In the FHWA Bridge Rail Memorandum, May 30, 1997, the Ohio Box Beam Bridge Rail was given the classification of a Report 350 Test Level 2 (TL-2) system based on successful performance in Report 230 MSL-2 tests.^{1,2} Although the MSL-2 performance level is close to TL-3, it was decided by the FHWA that adequate TL-3 performance cannot be measured without a pickup truck test.

Additionally, the ODOT GR-2.2 is relatively stiff and requires a transition system to connect it to a standard strong post guardrail (e.g., ODOT Type 5 guardrail). The transition system that is currently used with the ODOT GR-2.2 is called the ODOT Bridge Terminal Assembly Type 4 (ODOT GR-3.4).

Unlike rigid barriers, such as bridge rails, which require the transition section to be very rigid as it nears the attachment point to the barrier, the GR-2.2 has a range of stiffness values depending on the mounting conditions to the culvert or soil. The post mounting conditions for the GR-2.2 range from posts fully encased in concrete (very stiff system) to posts embedded in 3'-5" of soil (a much less stiff system). Refer to the standard drawings of the ODOT GR-2.2 in Appendix 1 for details. Because of the relatively high lateral stiffness of the FHWA approved TL-3 transition systems,ⁱ none would likely be compatible with the ODOT GR-2.2 over the full range of possible mounting conditions.

The purpose of this project was to assess the performance of both the ODOT GR-2.2 guardrail and the ODOT GR-3.4 transition system under TL-3 conditions, propose any modifications that would improve their crashworthiness and, ultimately, to ensure that the final designs qualify for use on the National Highway System (NHS) as TL-3 systems.

ⁱ See list of approved systems on the FHWA website at http://safety.fhwa.dot.gov/roadway_dept/road_hardware/longbarriers.htm

RESEARCH OBJECTIVES

The objectives of this research were to:

Phase 1

- Evaluate the performance of the ODOT Type 5 Tubular Backup Guardrail system (ODOT GR-2.2) and determine if the system is likely to qualify for use on Federal Highways as a TL-3 system.
- Identify any weaknesses of the system that may affect its performance and propose any changes (if they are needed) to the system that will result in successful performance under test level 3 conditions.

Phase 2

- Evaluate the performance of the ODOT Bridge Terminal Assembly Type 4 (ODOT GR-3.4) for use with the ODOT Type 5 Tubular Backup Guardrail system and determine if it qualifies as a TL-3 system
- Identify any weaknesses of the system that may affect its performance, identify other TL-3 transitions that may work more effectively with the ODOT GR-2.2 or propose any changes to the current system that will result in improved performance

Phase 3

- Conduct full-scale crash tests consistent with NCHRP Report 350 Test 3-11 to verify the performance of the final design of the guardrail and transition systems.
- Obtain acceptance letter from FHWA that the system qualifies for use on the NHS as a TL-3 system

To achieve these objectives, analyses of the guardrail and transition systems were performed using the LS-DYNA finite element analysis software to simulate NCHRP Report 350 Test 3-10 and Test 3-11 impact scenarios. Finite element models of the guardrail and transition were developed by Battelle staff for use in this research. The vehicle models used in the analyses were the best “off the shelf” models that were available. The vehicle models were developed at the National Crash Analysis Center (NCAC) in Ashburn, VA and have been further modified by various researchers over the years to improve their fidelity in analysis of impact conditions corresponding to Test 3-10 and 3-11.^{3,4}

RESEARCH APPROACH

Two analysis methods were considered for use in the study: finite element (F.E.) analysis and full-scale crash testing. Since the early 1990's finite element analysis has become a fundamental part of the design and analysis of roadside safety hardware. F.E. analysis is capable of dealing with the highly nonlinear behavior associated with nonlinear material properties, large deformations and strain-rate effects which are all inherent in high energy crash events.

The use of F.E. analysis provides a very cost effective means of thoroughly evaluating the mechanics (stress, strain, energy, etc.) of individual components of the guardrail, as well as the apparent performance of the guardrail system as a whole. For example, once a finite element model has been developed, the cost of making simple modifications to the system's design is very straight forward and many design modifications can be evaluated at minimal cost compared to full-scale testing. The data collection process using F.E. analysis is trivial and thus detailed information regarding performance of critical components can be obtained very easily compared to the data collection requirements in full-scale tests. Thus when failure occurs, the cause of failure can be identified directly from the analysis and measures can be taken to correct the deficiency.

The advantage of full-scale crash tests is that they are actual physical impact events where there is little ambiguity about the results. The disadvantage is that they are costly and it is seldom feasible to perform very many tests. Another disadvantage of full-scale testing is that it is not feasible to collect detailed data at every critical point in the system, thus when a test fails, a forensic approach is often necessary in order to determine the actual cause of failure. Although full-scale testing is not an efficient means of analysis in the design stages of a system, it is very important for the final verification of system performance and is often required for qualification of roadside safety hardware by the FHWA for use on the National Highway System (NHS).

The basic research approach taken in this study was to first critically evaluate the crash performance of the ODOT GR-2.2 guardrail and the ODOT GR-3.4 transition systems using F.E. analysis. The results of those analyses were then used to identify any deficiencies in the systems'

designs and modifications were made to correct those deficiencies. The modified systems were again evaluated using F.E. analysis to verify successful crash performance. Once successful designs were achieved, the FHWA was solicited for approval that the final designs qualify as TL-3 systems for use on the NHS. If FHWA approval could not be obtained based solely on the results of the analysis then full-scale crash testing would be used to verify the systems' performance.

PHASE I

Phase 1 involved analysis of the ODOT GR-2.2 guardrail for TL-3 impact conditions and suggest any improvements that would enhance the system's performance and ensure that it will successfully pass TL-3 tests.

Analysis Criteria

There are two tests required in NCHRP Report 350 for qualifying a guardrail as a TL-3 system: Test 3-10 and Test 3-11. Test 3-10 involves an 820-kg small car (e.g, Geo Metro) impacting at the critical impact point of the guardrail at a speed of 62 mph (100 km/hr) and at an impact angle of 20 degrees. Test 3-11 involves a 2000-kg pickup truck (e.g., Chevrolet C2500) impacting at the critical impact point of the guardrail at a speed of 62 mph (100 km/hr) and at an impact angle of 25 degrees.

The performance of the guardrail is evaluated based on criteria for structural adequacy of the barrier, vehicle stability during and after redirection, and occupant risk factors. In particular, NCHRP Report 350 requires that the guardrail must redirect the vehicle without allowing the vehicle to penetrate behind the system, the vehicle must remain upright during and after redirection, occupant impact with the interior of the vehicle must not exceed velocities more than 39.3 ft/s (12 m/s) and the longitudinal ridedown accelerations of the occupant must not exceed 20 g's.

Guardrail Mounting Options

The ODOT Type 5 guardrail with tubular backup uses a different post type and anchoring mechanism depending on the amount of soil cover over the culvert (see Appendix 1 for details), as listed below:

- Cover depth < 1.0 ft
 - Post Type = W6x25
 - Post mounted to top of culvert with partial soil cover
- $1.0 < \text{Cover depth} < 2'-6''$
 - Post Type = W8x28
 - Post mounted to top of culvert with partial soil cover
- $2'-6'' < \text{Cover depth} < 3'-5''$
 - Post Type = W6x25
 - Post encased in 2.5 ft of concrete (starting at grade)
- Cover depth > 3'-5''
 - Post Type = W6x25
 - Post embedded in soil 3'-5'' deep

It was not be feasible to evaluate every scenario of soil cover, post type and post mounting condition, thus two post mounting conditions were selected for evaluation in the analysis: 1) posts completely encased in concrete and 2) posts embedded in 3'-5'' of soil. These mounting conditions represent the most stiff and the most flexible boundary condition, respectively, for the system and were chosen because they bound the problem (i.e. the performance of the other mounting options should fall somewhere between these two scenarios).

Finite element models of the ODOT GR-2.2 guardrail and the ODOT GR-3.4 transition systems were developed and the LS-DYNA finite element analysis software was used to simulate NCHRP Report 350 Test 3-10 and Test 3-11 impact conditions.

The results of the analyses were critically evaluated in order to identify deficiencies in the various components of the system that may affect its overall performance. Modifications were then proposed to correct the problem. The proposed modifications incorporated as much of the

existing hardware as possible and required minimal added cost for implementation and retrofit of currently installed systems. The modified systems were then evaluated using F.E. analysis to ensure that they would result in successful performance under test level 3 conditions.

PHASE II

Phase 2 involved analysis of the ODOT GR-3.4 transition system, which is currently used with ODOT GR-2.2, and to suggest any improvements to the system that would enhance its performance. Other TL-3 transitions systems were also to be considered as potential candidates for use as a transition to the ODOT GR-2.2 guardrail.

The finite element models developed in Phase 1 were used to evaluate the TL-3 performance of the ODOT Bridge Terminal Assembly Type 4 (ODOT GR-3.4) and its compatibility as a transition system for the ODOT Type 5 Tubular Backup guardrail.

PHASE III

Phase 3 involved verification that the final guardrail and transition designs were TL-3 approved systems, and ultimately, to receive FHWA acceptance for the use of the systems on the NHS. Verification of TL-3 performance is typically done through full-scale crash testing which was included in the original research approach; however, full-scale testing was not required by FHWA due to sufficient evidence of successful performance of the final system design demonstrated in the F.E. analysis.

PHASE I – EVALUATION AND REDESIGN OF THE ODOT GR-2.2 GUARDRAIL

MODEL DEVELOPMENT

C2500 Vehicle Model

The vehicle type recommended for NCHRP Report 350 Test 3-11 is the 2000P test vehicle (e.g., Chevrolet 2500 and GMC 2500). A finite element model of the Chevrolet 2500, called the C2500 model, was developed by the National Crash Analysis Center at George Washington University under Federal Highway Administration (FHWA) sponsorship. A modified version of the NCAC C2500 Version 9 reduced element pickup truck finite element model was used to simulate the impact of a 2000P vehicle into the ODOT Type 5 Tubular Backup Guardrail system (ODOT GR-2.2 guardrail). The mass of the vehicle is 2000 kg and the center of gravity is at approximately 737 mm above ground.

Several modifications were made to the suspension system components of the model in an earlier study by researchers at Worcester Polytechnic Institute.^{3,4} This version of the model has been used extensively by members of the research team in previous studies for simulating vehicle-to-guardrail impacts and the performance of the model in those analyses were satisfactory.^{5,6}

820C Vehicle Model

The vehicle type recommended for NCHRP Report 350 Test 3-10 is the 820C test vehicle (e.g., 820-kg Geo Metro). A finite element model of the Geo Metro was developed by the National Crash Analysis Center at George Washington University under Federal Highway Administration (FHWA) sponsorship. Unlike the NCAC C2500 finite element model, the NCAC Geo Metro model has not been used as extensively by the crash analysis community so the accuracy and robustness of the model are not well known. In fact, there is very limited full-scale test data involving the use of the Geo Metro vehicle with longitudinal barriers, thus validation of the model's results in such analyses are also limited.

As part of a study conducted by the Texas Transportation Institute (TTI) under the sponsorship of the National Cooperative Highway Research Program (Project NCHRP 22-19), some

assessments and modifications of the Geo Metro vehicle model have been made. The suspension and tires of the model were significantly modified by TTI using a preprocessor called Virtual Proving Ground (VPG) Version 2.0, developed by Engineering Technology Associates, Inc.

In an effort to validate (at some level) the Geo Metro finite element model, Battelle sought existing physical crash test data for this vehicle. Full-scale test data (Test No. 511 on 5/6/97) from a study sponsored by the California Department of Transportation (CALTRANS) was used to verify the fidelity of the model with TTI modifications.⁷ The CALTRANS study involved a 1992 Geo Metro impacting the Type 70 Bridge Rail (i.e., a single slope concrete barrier with 9.1 degree face and 810 mm tall) under impact condition consistent with NCHRP Report 350 test 3-10.

The modified Geo Metro model provided satisfactory results regarding the overall kinematics of the vehicle. See Appendix 2 for analysis results.

ODOT GR-2.2 Guardrail Model

The guardrail model consisted of two 4.1 m lengths of 12-gauge w-beam elements backed up with TS 203x101x4.76 mm structural tubing and supported by five W6x25 posts spaced 1.9 m on center, as illustrated in Figure 2 and Figure 3. The height of the guardrail was 550 mm from the ground to the center of the w-beam rail element. The bolted connections of the w-beam and backup tube to the support posts were modeled explicitly, however, the nuts and bolt head were modeled as rigid material since deformations in these areas were expected to be insignificant in the results. The system also included a transition section (ODOT GR-3.4) on the upstream and downstream ends of the guardrail. Figure 4 shows the model with the upstream transition included. The total length of the guardrail system, including the transition sections, was 15.5 m. The boundary conditions at the ends of the w-beams on the transition sections are modeled with non-linear springs that simulate anchor conditions corresponding to the SEW03 (designation from AASHTO's *A Standardized Guide to Highway Barrier Hardware*) with a ground-line strut between the anchor posts.

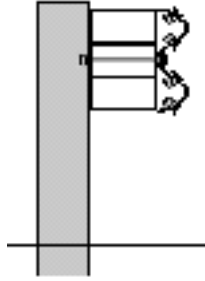

Figure 2: Cross-section view of guardrail model

As discussed earlier, it was not be feasible to evaluate every scenario of soil cover, post type and post mounting condition, thus two post mounting conditions were selected for evaluation in the analysis: 1) posts completely encased in concrete and 2) posts embedded in 3'-5" of soil. These mounting conditions represent the most stiff and the most flexible boundary condition, respectively, for the system and were chosen because they bound the problem (i.e. the performance of the other mounting options should fall somewhere between these two scenarios).

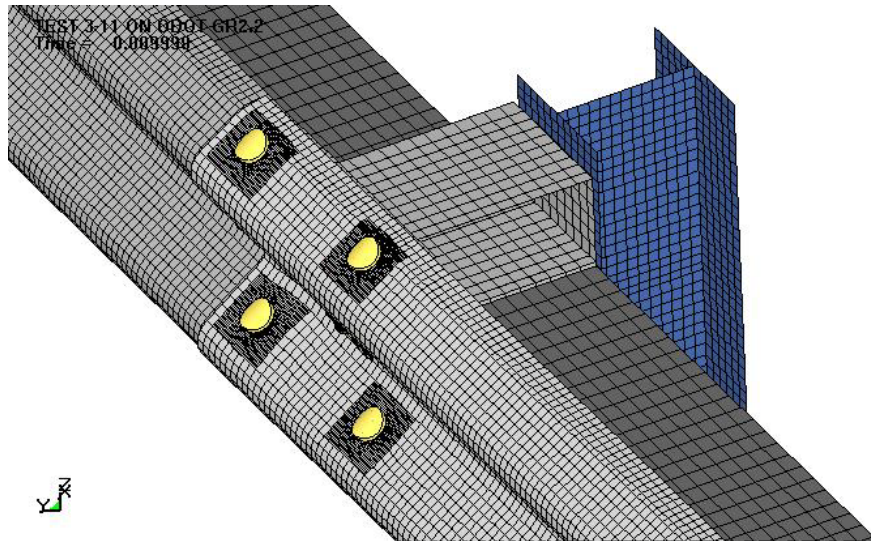

Figure 3: Isometric view illustrating typical components of guardrail model.

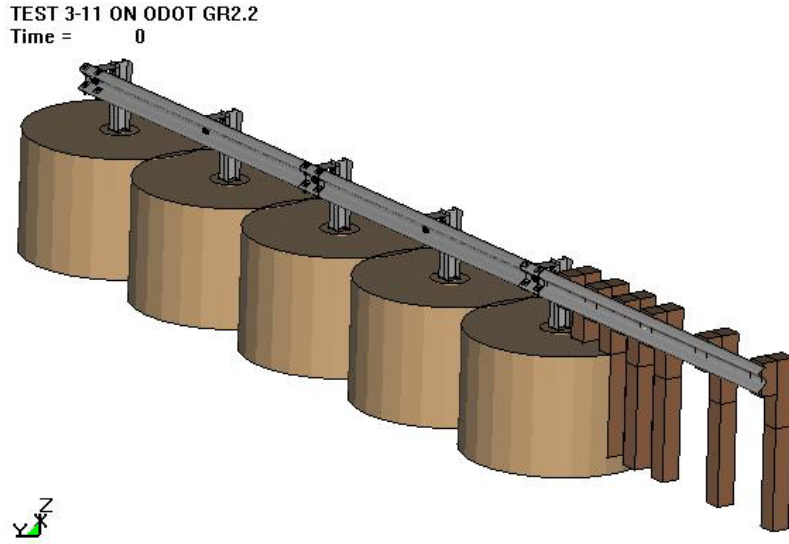

Figure 4: ODOT GR-2.2 guardrail model with ODOT GR-3.4 transition on the upstream end

For the case of posts completely encased in concrete, the posts were modeled with fixed boundary conditions at the groundline. For the case of posts embedded in 3’-5” of soil, the posts were modeled embedded in a “soil bucket,” which was modeled as a continuum of solid lagrangian elements, as illustrated in Figure 4. The soil material was modeled using material type ***MAT_DRUCKER_PRAGER** in LS-DYNA. The properties of the soil model were consistent with NCHRP Report 350 standard soil. The interaction between the post and soil was modeled using the LS-DYNA contact definition, ***CONTACT_AUTOMATIC_NODES_TO_SURFACE**.

ANALYSIS OF THE ODOT GR-2.2 GUARDRAIL

Guardrail Posts in Concrete Foundation – Test 3-10

The finite element models of the Geo Metro vehicle and the ODOT GR-2.2 guardrail were used to simulate NCHRP Report 350 Test 3-10. In accordance with Test 3-10, the vehicle impacts the guardrail at 100 km/hr at an angle of 20 degrees with respect to the rail. The impact point of the system was 0.50 m downstream of the first post (refer to Figure 5). Time-history data (e.g., accelerations, velocities, displacements) were collected at the center of gravity of the vehicle in a coordinate frame local to the vehicle using the accelerometer feature in ls-dyna.

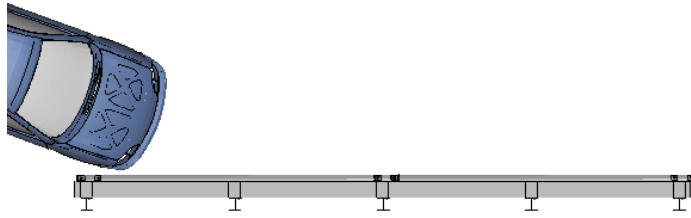
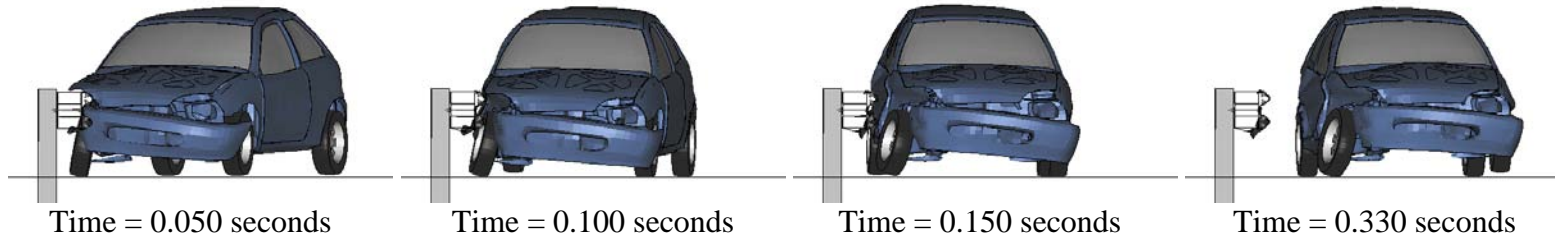

Figure 5: Vehicle impacts guardrail at 0.50 m downstream of post 1

The results of the analysis indicated that the guardrail system would safely contain and redirect the vehicle, meeting all safety criteria of Report 350. The exit velocity of the truck was 73.83 km/hr at an angle of 5.0 degrees. The maximum roll and pitch angular displacements of the vehicle was 1.7 degrees (away from the guardrail) and 2.8 degrees (front of vehicle pitches upward), respectively. The occupant impact velocity in the longitudinal direction was 5.6 m/s and the highest 0.010-second occupant longitudinal ridedown acceleration was -12.1 g. Table 1 and Figure 6 provide a summary of analysis results based on Report 350 evaluation criteria. More details of the F.E. analysis results are presented in Appendix 3.

Table 1: Evaluation Criteria and Simulation Summary (Guardrail Posts in Concrete Foundation - Test 3-10)

Evaluation Factors	Evaluation Criteria	Test Results	Assessment			
Structural Adequacy	A. Test article should contain and redirect the vehicle; the vehicle should not penetrate, under-ride or over-ride the installation although controlled lateral deflection of the test article is acceptable.	Vehicle smoothly redirected with minimal deformation to the barrier	Pass			
Occupant Risk	D. Detached elements, fragments or other debris from the test article should not penetrate or show potential for penetrating the occupant compartment, or present an undue hazard to other traffic, pedestrians or other personnel in a work zone. Deformations of, or intrusions into, the occupant compartment that could cause serious injuries should not be permitted.	The vehicle model cannot reproduce failure or rupture of elements, however, the analysis indicated that only minimal deformation of the occupant compartment would be expected.	N. A.			
	F. The vehicle should remain upright during and after collision although moderate roll, pitching and yawing are acceptable.	The vehicle remained upright with minimal roll, pitch and yaw. Maximum roll angle: 1.7 deg. Maximum pitch angle 2.8 deg.	Pass			
	H. Occupant impact velocities should satisfy the following:	Longitudinal 5.6 m/s Lateral 7.7 m/s	Pass			
	Occupant Impact Velocities Limits [m/s]					
	<table border="1" data-bbox="415 932 1050 1013"> <thead> <tr> <th>Component</th> <th>Preferred</th> <th>Maximum</th> </tr> </thead> <tbody> <tr> <td>Longitudinal and Lateral</td> <td>9</td> <td>12</td> </tr> </tbody> </table>			Component	Preferred	Maximum
Component	Preferred	Maximum				
Longitudinal and Lateral	9	12				
I. Occupant ridedown accelerations should satisfy the following:	Longitudinal 12.1 g Lateral 10.1 g	Pass				
Occupant Ridedown Accelerations Limits [G's]						
<table border="1" data-bbox="415 1078 1050 1159"> <thead> <tr> <th>Component</th> <th>Preferred</th> <th>Maximum</th> </tr> </thead> <tbody> <tr> <td>Longitudinal and Lateral</td> <td>15</td> <td>20</td> </tr> </tbody> </table>			Component	Preferred	Maximum	Longitudinal and Lateral
Component	Preferred	Maximum				
Longitudinal and Lateral	15	20				
Vehicle Trajectory	K. After collision is preferable that the vehicle's trajectory not intrude into adjacent traffic lanes.	Vehicle did not intrude	Pass			
	M. The exit angle from the test article preferably should be less than 60 percent of test impact angle, measured at time of vehicle loss of contact with test device.	Exit angle 5 deg., 25% of the impact angle.	Pass			



Barrier Type ODOT GR-2.2 w/posts in concrete

Vehicle Model

Type TTI Geo Metro

Mass 800 kg

Initial Conditions

Speed 100 km/hr

Angle 20 degrees

Exit Conditions

Speed 73.83 km/hr

Angle 5 degrees

Maximum Roll Angle 1.7 degrees

Maximum Pitch Angle 2.8 degrees

Vehicle Stability Very Stable Redirection

Occupant Impact Velocity

Longitudinal 6.5 < 12 m/s

Lateral 9.1

Occupant Ridedown Deceleration (g's)

Longitudinal 12.1 < 20 g's

Lateral 10.1

Maximum 50 ms Moving Average Acceleration (g's)

Longitudinal 10.9

Lateral 16.9

Vertical 2.5

THIV (m/s) 10.5

PHD (g's) 11.0

ASI 1.93

Figure 6: Summary of analysis results for Test 3-10 on ODOT GR-2.2 guardrail with guardrail posts in concrete foundation

Guardrail Posts in Concrete Foundation – Test 3-11

The analysis was performed according to the impact conditions specified in NCHRP Report 350 test 3-11 (i.e., 2000-kg pickup impacts at 100 km/hr at an impact angle of 25 degrees at the critical impact point (CIP) of the system). The impact point of the system was 0.35 m downstream of the first post (refer to Figure 7). Time-history data (e.g., accelerations, velocities, displacements) were collected at the center of gravity of the vehicle in a coordinate frame local to the pickup truck using the accelerometer feature in Is-dyna.

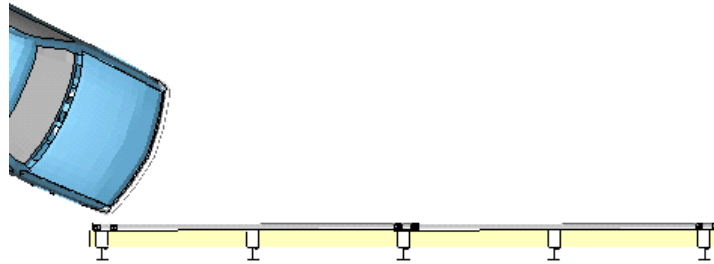

Figure 7: Vehicle impacts guardrail at 0.35 m downstream of post 1

The results of the analysis indicated that the guardrail system would safely contain and redirect the vehicle, meeting all safety criteria of Report 350. Although the analysis resulted in successful redirection, there was some indication of a potential for wheel snag under slightly higher impact severity (e.g., higher mass, higher velocity or higher angle).

The exit velocity of the truck was 76.0 km/hr at an angle of 11.7 degrees. The maximum roll and pitch angular displacements of the truck was -3.2 degrees (toward the guardrail) and -6.2 degrees (rear of vehicle pitches upward), respectively. The occupant impact velocity in the longitudinal direction was 6.5 m/s and the highest 0.010-second occupant longitudinal ridedown acceleration was -6.2 g. Table 2 and Figure 8 provide a summary of analysis results based on Report 350 evaluation criteria. More details of the F.E. analysis results are presented in Appendix 4.

Table 2: Evaluation Criteria and Simulation Summary (Guardrail Posts in Concrete Foundation - Test 3-11)

Evaluation Factors	Evaluation Criteria	Test Results	Assessment	
Structural Adequacy	A. Test article should contain and redirect the vehicle; the vehicle should not penetrate, under-ride or over-ride the installation although controlled lateral deflection of the test article is acceptable.	Vehicle smoothly redirected with minimal deformation to the barrier	Pass	
Occupant Risk	D. Detached elements, fragments or other debris from the test article should not penetrate or show potential for penetrating the occupant compartment, or present an undue hazard to other traffic, pedestrians or other personnel in a work zone. Deformations of, or intrusions into, the occupant compartment that could cause serious injuries should not be permitted.	Not possible to evaluate since the vehicle model cannot reproduce failure or rupture of elements.	N. A.	
	F. The vehicle should remain upright during and after collision although moderate roll, pitching and yawing are acceptable.	The vehicle remained upright and stable after exiting the system. Maximum roll angle: 3.2 deg. Maximum pitch angle 6.2 deg.	Pass	
	H. Occupant impact velocities should satisfy the following:		Longitudinal 6.5 m/s Lateral 9.1 m/s	Pass
	Occupant Impact Velocities Limits [m/s]			
	Component Longitudinal and Lateral	Preferred 9 Maximum 12		
I. Occupant ridedown accelerations should satisfy the following:		Longitudinal 6.2 g Lateral 8.4 g	Pass	
Occupant Ridedown Accelerations Limits [G's]				
Component Longitudinal and Lateral	Preferred 15 Maximum 20			
Vehicle Trajectory	K. After collision is preferable that the vehicle's trajectory not intrude into adjacent traffic lanes.	Vehicle did not intrude into adjacent traffic lane	Pass	
	M. The exit angle from the test article preferably should be less than 60 percent of test impact angle, measured at time of vehicle loss of contact with test device.	Exit angle 11.7 deg., 47% of the impact angle.	Pass	

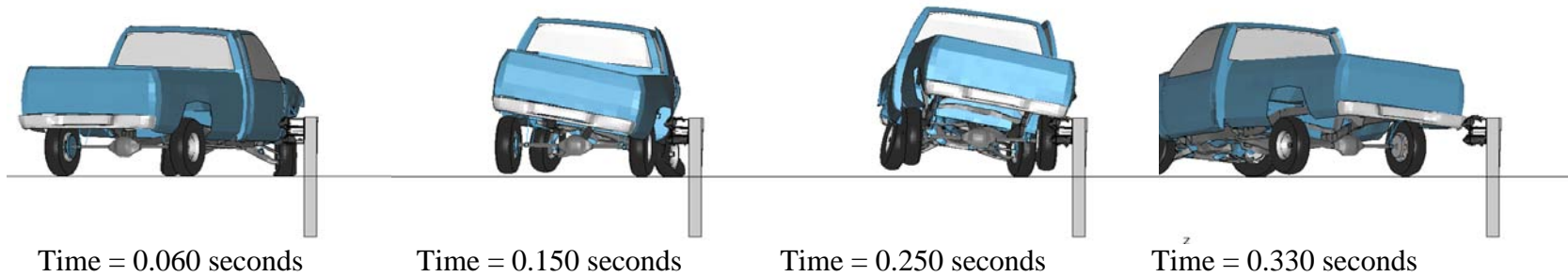

Barrier Type ODOT GR-2.2 w/post in concrete

Vehicle Model

Type Modified NCAC C2500
 Mass 2000 kg

Initial Conditions

Speed 100 km/hr
 Angle 25 degrees

Exit Conditions

Speed 76.0 km/hr
 Angle 11.7 degrees

Maximum Roll Angle 3.2 degrees

Maximum Pitch Angle 6.2 degrees

Vehicle Stability Acceptable

Occupant Impact Velocity

Longitudinal 6.5 < 12 m/s
 Lateral 9.1

Occupant Ridedown Deceleration (g's)

Longitudinal 6.2 < 20 g's
 Lateral 8.4

Maximum 50 ms Moving Average Acceleration (g's)

Longitudinal 10.5
 Lateral 15.6
 Vertical 2.6

THIV (m/s) 10.5

PHD (g's) 11.0

ASI 1.93

Figure 8: Summary of analysis results for Test 3-11 on ODOT GR-2.2 guardrail with guardrail posts in concrete foundation

Guardrail Posts in Soil Foundation – Test 3-11

In the case of a cover depth over a culvert of greater than 3'-5", ODOT uses the GR-2.2 guardrail with steel W6x25 section posts embedded in soil 3'-5". The F.E. analysis of this system was performed according to the impact conditions specified in NCHRP Report 350 test 3-11 (i.e., 2000-kg pickup impacts at 100 km/hr at an impact angle of 25 degrees at the critical impact point (CIP) of the system). The impact point of the system was 0.35 m downstream of the first post of the GR-2.2 section (refer to Figure 9). Time-history data (e.g., accelerations, velocities, displacements) were collected at the center of gravity of the vehicle in a coordinate frame local to the pickup truck using the accelerometer feature in Is-dyna.

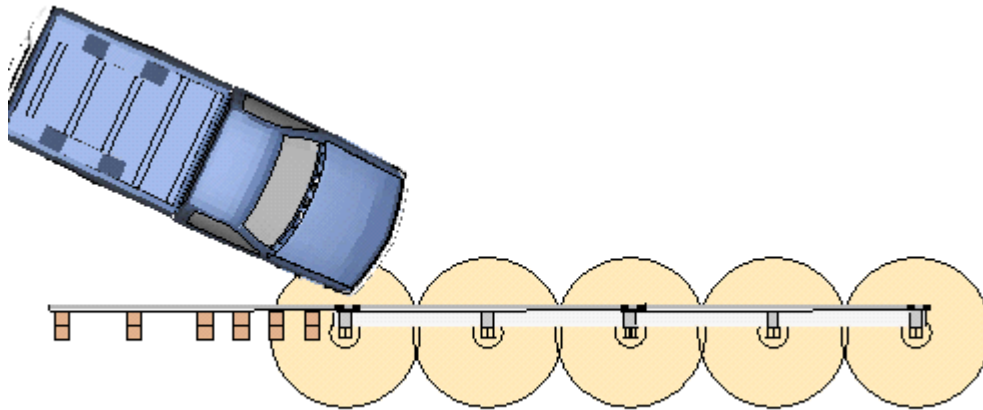
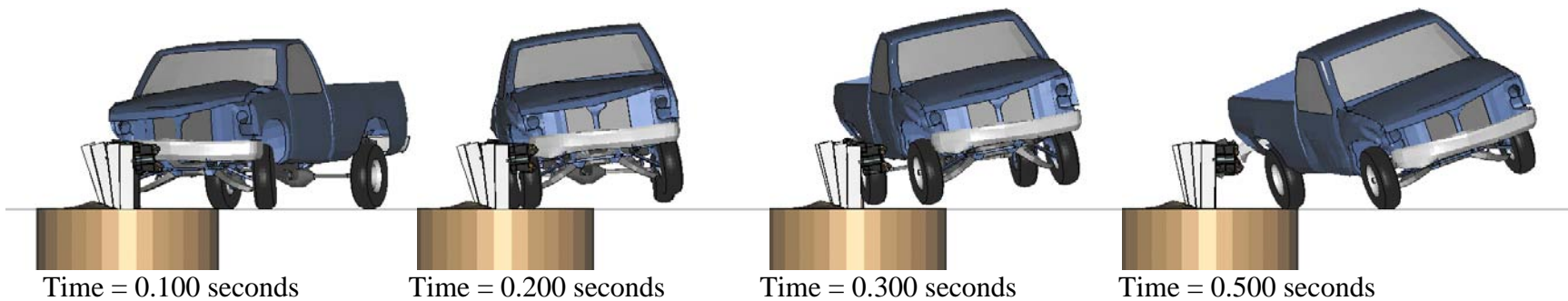

Figure 9: Vehicle impacts guardrail at 0.35 m downstream of post 1

The results of the finite element analysis indicate that the guardrail will perform satisfactorily, however, the vehicle did experience moderate roll during redirection. The guardrail is sufficiently strong enough to contain and redirect the 2000-kg pickup in NCHRP Report 350 Test level 3 conditions with moderate deflection of the system. The maximum deflection of the guardrail was 413 mm. The exit velocity of the truck was 75.0 km/hr at an angle of 17 degrees. The maximum roll and pitch angular displacements of the truck was -19.6 degrees (toward the guardrail) and -2.3 degrees (rear of vehicle pitches upward), respectively. The occupant impact velocity in the longitudinal direction was 4.2 m/s and the highest 0.010-second occupant longitudinal ridedown acceleration was -7.9 g. Table 3 and Figure 10 provide a summary of analysis results based on Report 350 evaluation criteria. More details of the F.E. analysis results are presented in Appendix 5.

Table 3: Evaluation Criteria and Simulation Summary (Guardrail Posts in Soil Foundation - Test 3-11)

Evaluation Factors	Evaluation Criteria	Test Results	Assessment	
Structural Adequacy	A. Test article should contain and redirect the vehicle; the vehicle should not penetrate, under-ride or over-ride the installation although controlled lateral deflection of the test article is acceptable.	Vehicle was contained and redirected	Pass	
Occupant Risk	D. Detached elements, fragments or other debris from the test article should not penetrate or show potential for penetrating the occupant compartment, or present an undue hazard to other traffic, pedestrians or other personnel in a work zone. Deformations of, or intrusions into, the occupant compartment that could cause serious injuries should not be permitted.	Not possible to evaluate since the vehicle model cannot reproduce failure or rupture of elements.	N. A.	
	F. The vehicle should remain upright during and after collision although moderate roll, pitching and yawing are acceptable.	The vehicle remained upright but showed moderate roll angle. Maximum roll angle: 19.6 deg. Maximum pitch angle -2.3 deg. Maximum yaw angle 20.6 deg.	Pass	
	H. Occupant impact velocities should satisfy the following:		Longitudinal 4.2 m/s Lateral 6.5 m/s	Pass
	Occupant Impact Velocities Limits [m/s]			
	Component Longitudinal and Lateral	Preferred 9 Maximum 12		
I. Occupant ridedown accelerations should satisfy the following:		Longitudinal 7.9 g Lateral 14.9 g	Pass	
Occupant Ridedown Accelerations Limits [G's]				
Component Longitudinal and Lateral	Preferred 15 Maximum 20			
Vehicle Trajectory	K. After collision is <i>preferable</i> that the vehicle's trajectory not intrude into adjacent traffic lanes.	Exit angle of the vehicle indicates that vehicle may intrude into adjacent traffic lane	Fail	
	M. The exit angle from the test article <i>preferably</i> should be less than 60 percent of test impact angle, measured at time of vehicle loss of contact with test device.	Exit angle 17.0 deg., 68% of the impact angle.	Fail	



Barrier Type ODOT GR-2.2 w/post in soil

Vehicle Model

 Type Modified NCAC C2500

 Mass 2000 kg

Initial Conditions

 Speed 100 km/hr

 Angle 25 degrees

Exit Conditions

 Speed 75.0 km/hr

 Angle 17.0 degrees

Maximum Roll Angle 19.6 degrees

Maximum Pitch Angle 2.3 degrees

Vehicle Stability Acceptable

Occupant Impact Velocity

 Longitudinal 4.2 < 12 m/s

 Lateral 6.5

Occupant Ridedown Deceleration (g's)

 Longitudinal 7.9 < 20 g's

 Lateral 14.9

Maximum 50 ms Moving Average Acceleration (g's)

 Longitudinal 4.7

 Lateral 8.1

 Vertical 2.9

THIV (m/s) 7.1

PHD (g's) 21.4

ASI 0.98

Figure 10: Summary of analysis results for Test 3-11 on ODOT GR-2.2 guardrail with guardrail posts in soil

Summary of ODOT GR-2.2 Analysis

Finite element analysis was used to evaluate the performance of the GR-2.2 guardrail system. It was not be feasible to evaluate every scenario of soil cover, post type and post mounting condition, thus two post mounting conditions were selected for evaluation in the analysis

- 1) Post completely encased in concrete
- 2) Posts embedded in 3'-5" of soil

These mounting conditions represent the most stiff and the most flexible boundary condition, respectively, for the system and were chosen because they bound the problem (i.e. the performance of the other mounting options should fall somewhere between these two scenarios).

The analyses indicated that the system would pass NCHRP Report 350 Test Level 3. However, for the case of the posts mounted in concrete, the analysis indicated that there was a slight potential for wheel snag on the posts. It is expected that for impact conditions more severe than those of Test 3-11 the potential for wheel snags increases significantly. Further discussion on this subject and means of addressing the problem are presented in the following section of this report.

IMPROVMENTS TO THE ODOT GR-2.2 GUARDRAIL

The analysis of the original guardrail design indicated that system would likely pass Report 350 test level 3 criteria, however, the results also identified a potential for the front wheel of the vehicle to get under the rail far enough to contact the guardrail posts, as shown in Figure 11. The steel W6x25 posts are very heavy and very stiff, and thus a wheel snag on the posts would likely result in high decelerations and possible vehicle instability.

The w-beam on the face of the system is much less stiff than the tubular backup, and as a result the tire of the vehicle compresses the lower part of the w-beam rail inward, wrapping the w-beam around the tube, as illustrated in Figures 12 and 13, allowing the tire to penetrate underneath the guardrail. The Finite element analysis did not result in the tire snagging on a guardrail post, however, it was inferred from the analysis results that the potential for tire snag exists, especially for more severe impact cases.

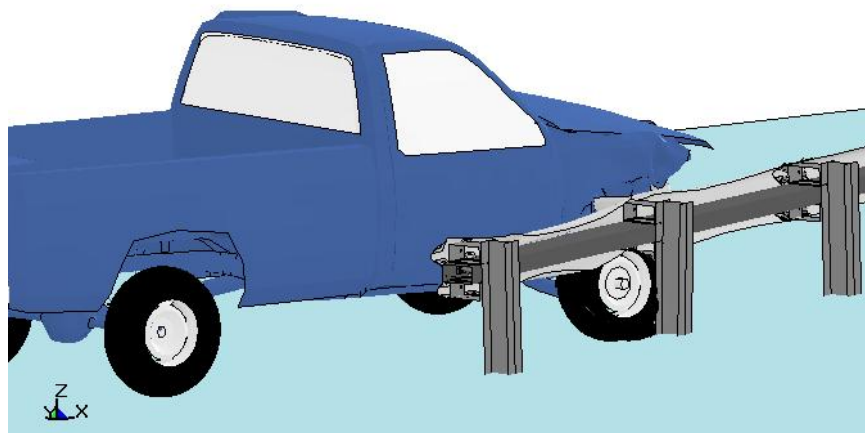

Figure 11: View from the F.E. analysis illustrating potential for tire snag on a guardrail post.

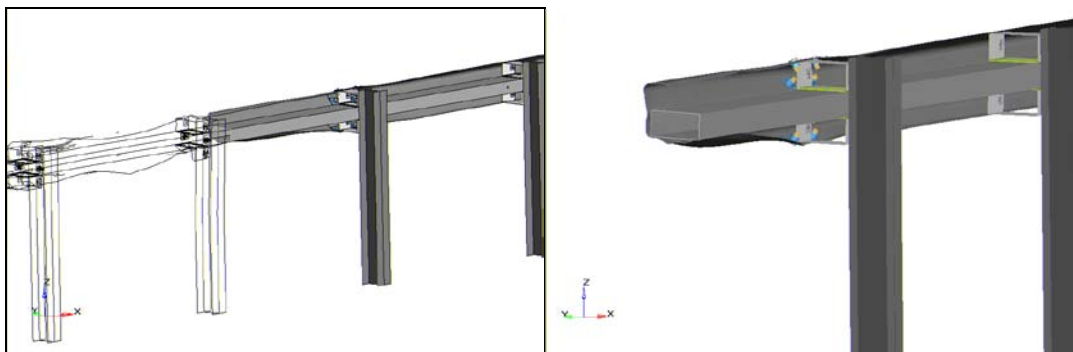

Figure 12: Cutaway view of the guardrail illustrating deformation of w-beam “wrapping” around tube section in Test 3-11 impact analysis.



Figure 13: View from the F.E. analysis illustrating the interaction of the tire with the guardrail

Proposed Design Modifications

Four modified systems were proposed to mitigate wheel snag and designs 1 through 3 were selected for further evaluation using F.E. analysis:

- 1) Two-tube tubular backup system
- 2) Rub-rail retrofit
- 3) Nested w-beam retrofit
- 4) Added tube through lower spacer block retrofit (*analysis not conducted*)

Design 1: Two-Tube Tubular Backup System

As opposed to having only one tube behind the w-beam for support, two thinner tubes could be used at the top and bottom of the w-beam, similar to the “long span” design shown in Figure 14. With such a design the guardrail would effectively have a taller face and make it less likely for the tire to push underneath.



Figure 14: Long-span guardrail across a culvert on HW 315 in Delaware, County.

Another system that uses a two-tube design is Texas T101 bridge rail, shown in Figure 15. The T101 was classified as a Report 350 TL-3 system in the FHWA Bridge Rail Memorandum of May 30, 1997 based on the following Report 230 testing:

- 2,780 lb. car impacting at 57.3 mph and 15.0 degrees
- 4,660 lb. car impacting at 60.2 mph and 15.0 degrees
- 4,630 lb. car impacting at 59.8 mph and 25.8 degrees

- 6,900 lb. bus impacting at 53.4 mph and 15 degrees
- 19,940 lb. bus impacting at 55.3 mph and 15.2 degrees
- 20,010 lb. bus impacting at 52.0 mph and 13.2 degrees
- 31,880 lb. bus impacting at 58.4 mph and 16.0 degrees

The modified design of the ODOT GR-2.2 with two-tube backup is shown in Figure 16 and includes:

- A spacer block between the two tubes
- Tubes and spacers are welded together
- One bolt with washers connects w-beam to post (same as original design)
- Standard post spacing of 1.9 m
- The tubes are bolted to the posts separately

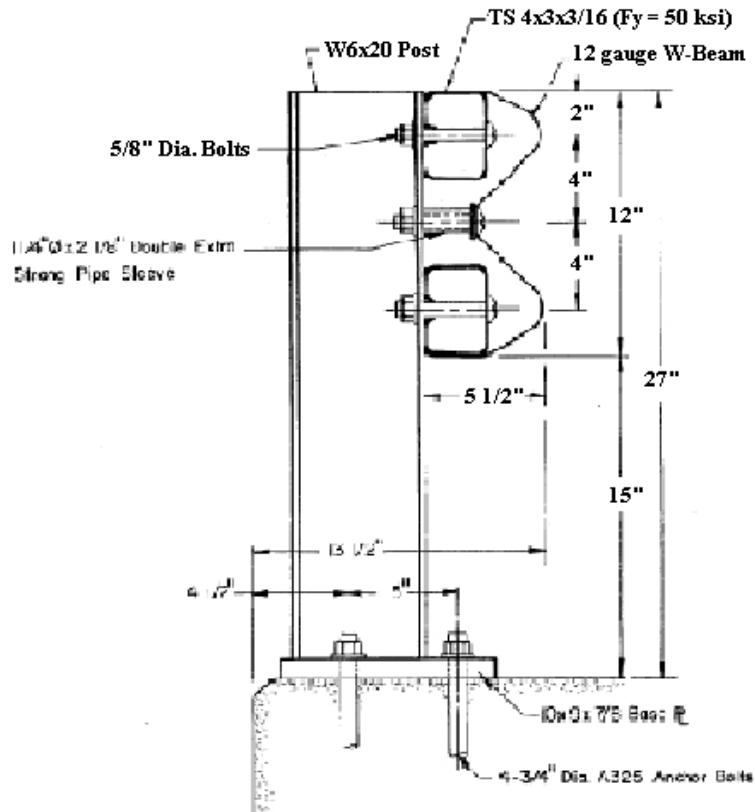

Figure 15: Drawing of the Texas T101 bridge rail

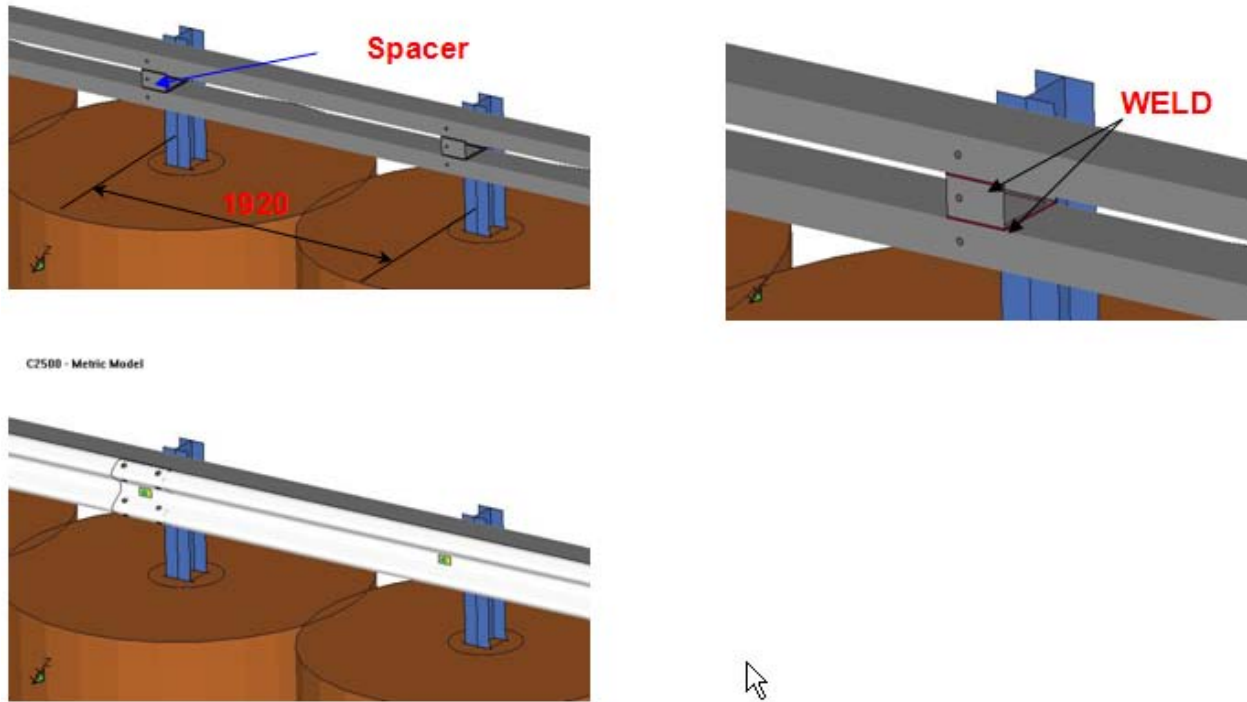

Figure 16: Finite element model of the modified GR-2.2 with two-tube backup design

The performance of the two-tube system was analyzed for NCHRP Report 350 Test 3-11 impact conditions. Two mounting conditions for the posts were simulated: 1) full concrete embedment and 2) 3'-5" embedment in soil. The results of those analyses are summarized below.

Full Concrete Embedment of Posts (Rigid Mounting)

The vehicle model impacted the guardrail system 0.35 m downstream of post 1. Upon contact, the vehicle was traveling at 100 km/hr at an angle of 25 degrees with respect to the rail. The results of the finite element analysis indicate that the guardrail will perform satisfactorily, however, the vehicle did experience moderate roll during redirection. The vehicle exited the system at approximately 0.370 seconds with an exit velocity of 84.6 km/hr at an angle of 10.1 degrees. The maximum roll and pitch angular displacements of the truck was -23.5 degrees (toward the guardrail) and -6.7 degrees (rear of vehicle pitches upward), respectively.

During impact and redirection, the wheel of the vehicle did not penetrate underneath the w-beam, as illustrated in Figure 17, thus there was little or no potential for wheel snag. Figure 18 shows

guardrail deformation of the two-tube system compared to the standard GR-2.2 system. In the two-tube system, the effective height of the barrier face was maintained, preventing the tire of the vehicle from getting under the rail. The vehicle did experience moderate roll angle during redirection, however, vehicle stability was maintained in the simulation.

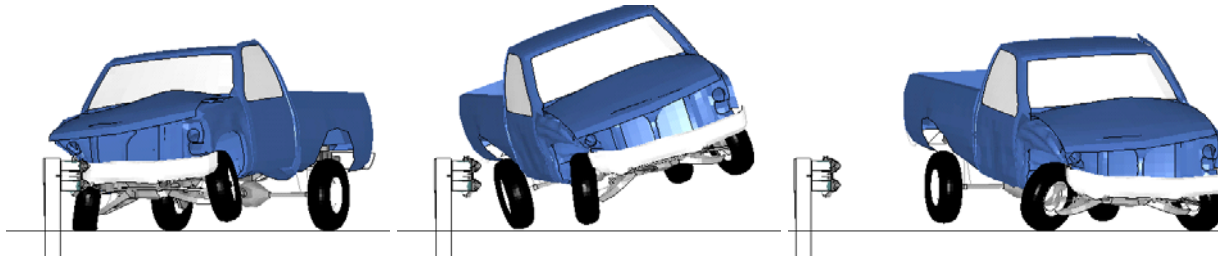

Figure 17: Sequential views of the simulated Test 3-11 impact event on the GR-2.2 with two-tube backup (posts in concrete)

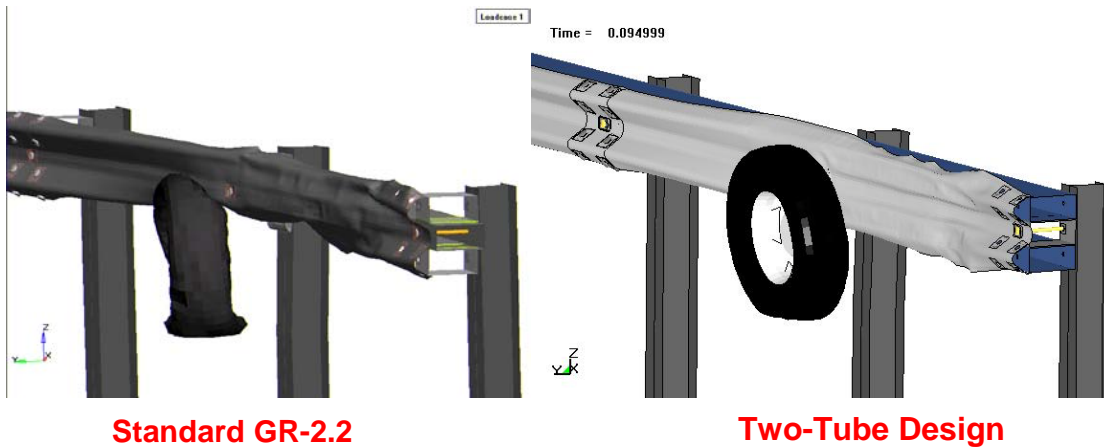

Figure 18: Comparison barrier deformation of the standard GR-2.2 design and the modified two-tube backup design.

The occupant impact velocity in the longitudinal direction was 5.9 m/s and the highest 0.010-second occupant longitudinal ridedown acceleration was -5.6 g. Table 4 and Figure 19 provide a summary of analysis results based on Report 350 evaluation criteria. More details of the F.E. analysis results are presented in Appendix 6.

Embedment of Posts in 3'-5" Soil

The vehicle model impacted the guardrail system 0.35 m downstream of post 1. Upon contact, the vehicle was traveling at 100 km/hr at an angle of 25 degrees with respect to the rail. During

impact the posts rotated back in the soil allowing the wheel to come near the base of the posts, however, contact with the posts was not likely. Figure 20 shows the posts pushed back in the soil and the relative distance between the tire and post. A series of snapshots of the analysis corresponding to key events is shown in Figure 21: maximum guardrail deformation, vehicle exiting the system and post impact trajectory of the vehicle. The analysis did indicate moderate roll angle of the vehicle during redirection, however, vehicle stability was maintained.

The vehicle exited the system at approximately 0.370 seconds with an exit velocity of 85.3 km/hr at an angle of 11.08 degrees. The maximum roll and pitch angular displacements of the truck was -30.7 degrees (toward the guardrail) and -6.1 degrees (rear of vehicle pitches upward), respectively.

Table 4: Evaluation Criteria and Simulation Summary for Two-Tube Design with Posts in Concrete Foundation - Test 3-11

Evaluation Factors	Evaluation Criteria	Test Results	Assessment	
Structural Adequacy	A. Test article should contain and redirect the vehicle; the vehicle should not penetrate, under-ride or over-ride the installation although controlled lateral deflection of the test article is acceptable.	Vehicle was contained and redirected	Pass	
Occupant Risk	D. Detached elements, fragments or other debris from the test article should not penetrate or show potential for penetrating the occupant compartment, or present an undue hazard to other traffic, pedestrians or other personnel in a work zone. Deformations of, or intrusions into, the occupant compartment that could cause serious injuries should not be permitted.	Not possible to evaluate since the vehicle model cannot reproduce failure or rupture of elements.	N. A.	
	F. The vehicle should remain upright during and after collision although moderate roll, pitching and yawing are acceptable.	The vehicle remained upright but showed moderate roll angle. Maximum roll angle: 23.5 deg. Maximum pitch angle -6.7 deg.	Pass	
	H. Occupant impact velocities should satisfy the following:		Longitudinal 5.9 m/s Lateral 9.3 m/s	Pass
	Occupant Impact Velocities Limits [m/s]			
	Component Longitudinal and Lateral	Preferred 9 Maximum 12		
I. Occupant ridedown accelerations should satisfy the following:		Longitudinal 5.6 g Lateral 11.6 g	Pass	
Occupant Ridedown Accelerations Limits [G's]				
Component Longitudinal and Lateral	Preferred 15 Maximum 20			
Vehicle Trajectory	K. After collision is <i>preferable</i> that the vehicle's trajectory not intrude into adjacent traffic lanes.	Vehicle did not intrude into adjacent traffic lane	Pass	
	M. The exit angle from the test article <i>preferably</i> should be less than 60 percent of test impact angle, measured at time of vehicle loss of contact with test device.	Exit angle 10 deg., 40% of the impact angle.	Pass	

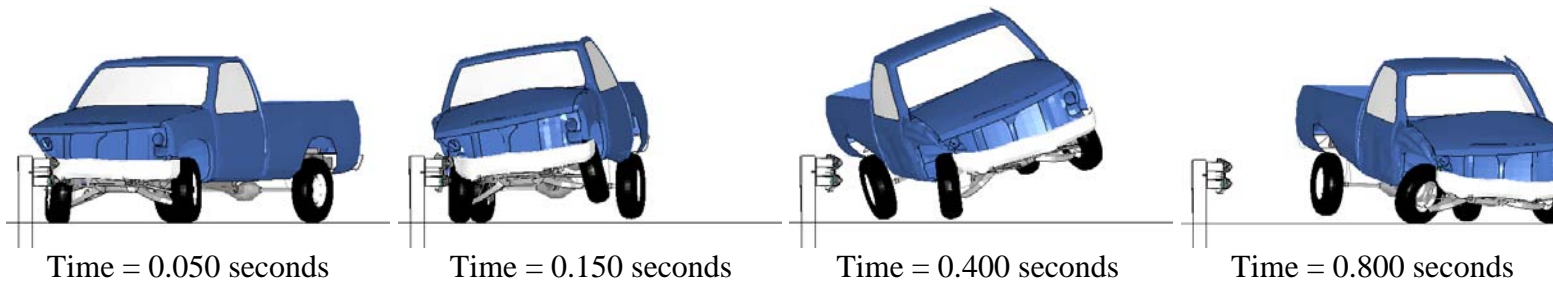

Barrier Type Modified ODOT GR-2.2 w/ two-tube backup (post in concrete)

Vehicle Model

Type Modified NCAC C2500

Mass 2000 kg

Initial Conditions

Speed 100 km/hr

Angle 25 degrees

Exit Conditions

Speed 84.60 km/hr

Angle 10.1 degrees

Maximum Roll Angle 23.5 degrees

Maximum Pitch Angle 6.7 degrees

Vehicle Stability Acceptable

Occupant Impact Velocity

Longitudinal 5.9 < 12 m/s

Lateral 9.3

Occupant Ridedown Deceleration (g's)

Longitudinal 5.6 < 20 g's

Lateral 11.6

Maximum 50 ms Moving Average Acceleration (g's)

Longitudinal 9.7

Lateral 17.1

Vertical 4.5

THIV (m/s) 10.5

PHD (g's) 11.9

ASI 2.05

Figure 19: Summary of analysis results for Test 3-11 on modified two-tube design with posts in concrete foundation

TEST 3-11 ON ODOT GR2.2
Time = 0.094999

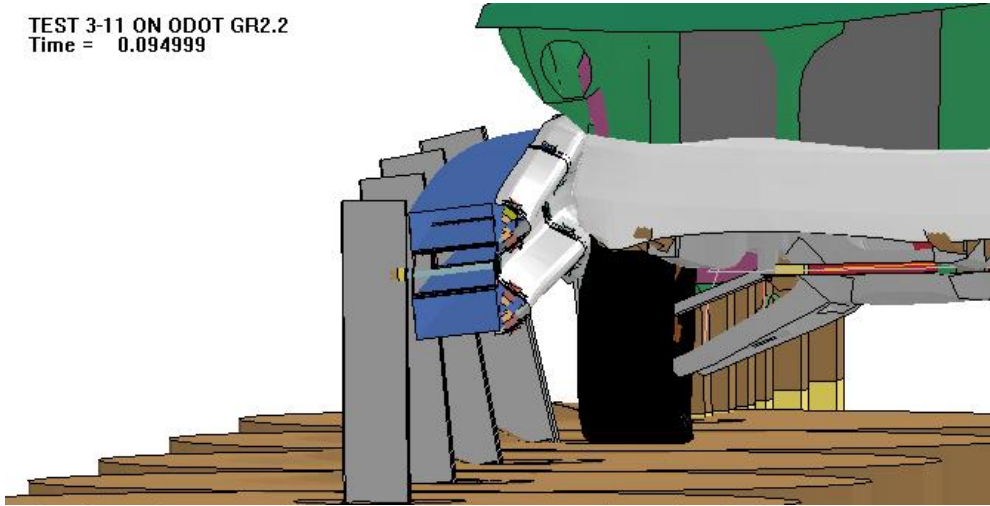

Figure 20: View from the F.E. analysis at maximum deflection of guardrail for the two-tube system with posts in soil

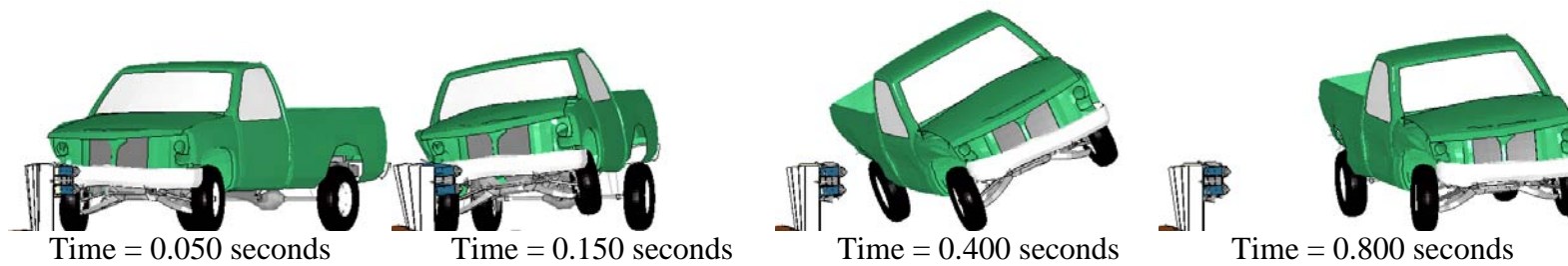

Figure 21: Sequential views of the simulated Test 3-11 impact event on the modified GR-2.2 with two-tube backup (posts in soil)

The occupant impact velocity in the longitudinal direction was 4.6 m/s and the highest 0.010-second occupant longitudinal ridedown acceleration was -5.1 g. Table 5 and Figure 22 provide a summary of analysis results based on Report 350 evaluation criteria. More details of the F.E. analysis results are presented in Appendix 6.

Table 5: Evaluation Criteria and Simulation Summary for Two-Tube Design with Posts in Soil Foundation - Test 3-11

Evaluation Factors	Evaluation Criteria	Test Results	Assessment	
Structural Adequacy	A. Test article should contain and redirect the vehicle; the vehicle should not penetrate, under-ride or over-ride the installation although controlled lateral deflection of the test article is acceptable.	Vehicle was contained and redirected	Pass	
Occupant Risk	D. Detached elements, fragments or other debris from the test article should not penetrate or show potential for penetrating the occupant compartment, or present an undue hazard to other traffic, pedestrians or other personnel in a work zone. Deformations of, or intrusions into, the occupant compartment that could cause serious injuries should not be permitted.	Not possible to evaluate since the vehicle model cannot reproduce failure or rupture of elements.	N. A.	
	F. The vehicle should remain upright during and after collision although moderate roll, pitching and yawing are acceptable.	The vehicle remained upright but showed moderate roll angle. Maximum roll angle: 30.7 deg. Maximum pitch angle -6.1 deg.	Pass marginal	
	H. Occupant impact velocities should satisfy the following:		Longitudinal 4.6 m/s Lateral 7.4 m/s	Pass
	Occupant Impact Velocities Limits [m/s]			
	Component Longitudinal and Lateral	Preferred 9 Maximum 12		
I. Occupant ridedown accelerations should satisfy the following:		Longitudinal 5.1 g Lateral 8.9 g	Pass	
Occupant Ridedown Accelerations Limits [G's]				
Component Longitudinal and Lateral	Preferred 15 Maximum 20			
Vehicle Trajectory	K. After collision is <i>preferable</i> that the vehicle's trajectory not intrude into adjacent traffic lanes.	Vehicle did not intrude into adjacent traffic lane	Pass	
	M. The exit angle from the test article <i>preferably</i> should be less than 60 percent of test impact angle, measured at time of vehicle loss of contact with test device.	Exit angle 13 deg., 52% of the impact angle.	Pass	



Barrier Type Modified ODOT GR-2.2 w/ two-tube backup (post in soil)

Vehicle Model

Type Modified NCAC C2500
 Mass 2000 kg

Initial Conditions

Speed 100 km/hr
 Angle 25 degrees

Exit Conditions

Speed 85.3 km/hr
 Angle 11.8 degrees

Maximum Roll Angle 30.7 degrees

Maximum Pitch Angle 6.1 degrees

Vehicle Stability Acceptable

Occupant Impact Velocity

Longitudinal 4.6 < 12 m/s
 Lateral 7.4

Occupant Ridedown Deceleration (g's)

Longitudinal 5.16 < 20 g's
 Lateral 8.9

Maximum 50 ms Moving Average Acceleration (g's)

Longitudinal 5.9
 Lateral 9.8
 Vertical 2.4

THIV (m/s) 8.1

PHD (g's) 10.5

ASI 1.19

Figure 22: Summary of analysis results for Test 3-11 on modified two-tube design with posts in soil foundation

Design 2: Rub-Rail Retrofit

Another design solution for improving the performance of the ODOT GR-2.2 guardrail was the simple modification of adding a rub-rail below the blockouts, which would serve to prevent the tires from snagging on the posts. The rub-rail will not, however, prevent the wheel from pushing underneath the w-beam and possibly impacting the spacer blocks. The rub-rail was placed 50.8 mm (2 inches) below the blockouts in the finite element model, as shown in Figure 23, and consisted of a single, continuous structural element 7.91 m long that spans across the entire length of the GR-2.2 guardrail. The rub-rail was modeled as a C6x8.2 steel section, which is a commonly used structural member for rub-rails in other roadside hardware. The C6x8.2 rub-rail element is designated as part number RLR01 in the *Standardized Guide to Highway Barrier Hardware*.

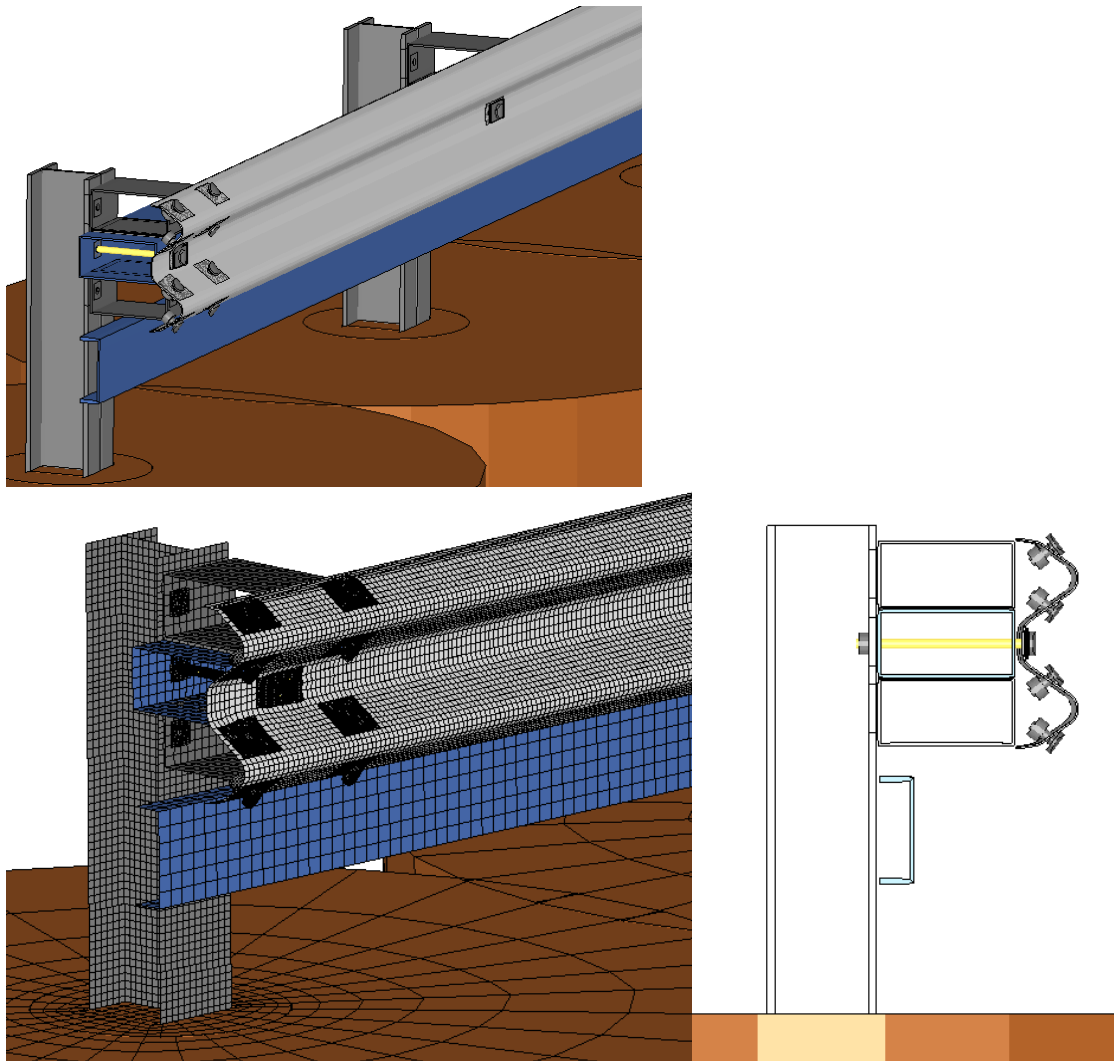

Figure 23: FE model of the modified ODOT GR-2.2 guardrail with rub-rail retrofit

The performance of the ODOT GR-2.2 with rub-rail was analyzed for NCHRP Report 350 Test 3-11 test conditions for two cases: 1) Full concrete embedment of the posts and 2) the posts mounted in 3'-5" of soil. The results of these analyses are summarized below.

Full Concrete Embedment of Posts

The vehicle model impacted the guardrail system 0.35 m downstream of post 1. Upon contact, the vehicle was traveling at 100 km/hr at an angle of 25 degrees with respect to the rail. The vehicle exited the system at approximately 0.420 seconds with an exit velocity of 78.8 km/hr at an angle of 17.5 degrees. The maximum roll and pitch angular displacements of the truck was -12.8 degrees (toward the guardrail) and -4.4 degrees (rear of vehicle pitches upward), respectively.

During impact the tire of the vehicle pushed under the w-beam rail and was successfully redirected by the rub-rail, as shown in Figure 24, with little or no risk of direct impact with a post. The vehicle experienced minimal roll angle during redirection and remained very stable throughout the simulated impact event.

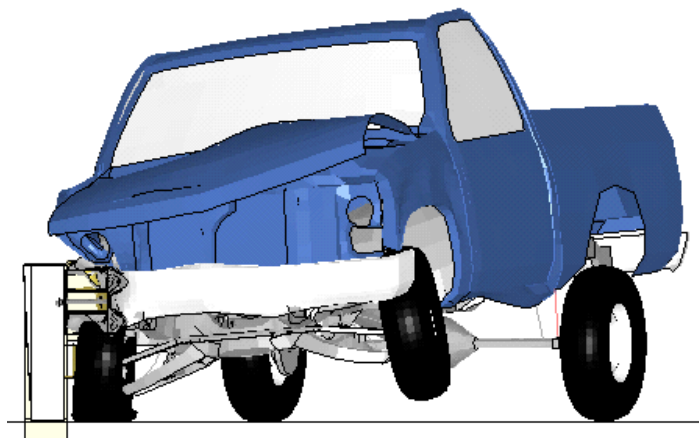
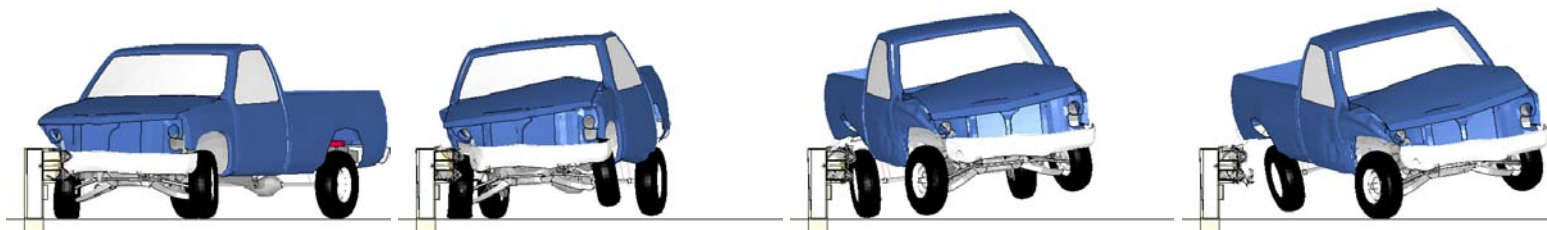

Figure 24: Wheel of vehicle successfully redirected by rub-rail

The occupant impact velocity in the longitudinal direction was 6.4 m/s and the highest 0.010-second occupant longitudinal ridedown acceleration was -4.0 g. Table 6 and Figure 25 provide a summary of analysis results based on Report 350 evaluation criteria.

Table 6: Evaluation Criteria and Simulation Summary for Rub-Rail Retrofit with Posts in Concrete Foundation - Test 3-11

Evaluation Factors	Evaluation Criteria	Test Results	Assessment	
Structural Adequacy	A. Test article should contain and redirect the vehicle; the vehicle should not penetrate, under-ride or over-ride the installation although controlled lateral deflection of the test article is acceptable.	Vehicle was contained and redirected	Pass	
Occupant Risk	D. Detached elements, fragments or other debris from the test article should not penetrate or show potential for penetrating the occupant compartment, or present an undue hazard to other traffic, pedestrians or other personnel in a work zone. Deformations of, or intrusions into, the occupant compartment that could cause serious injuries should not be permitted.	Not possible to evaluate since the vehicle model cannot reproduce failure or rupture of elements.	N. A.	
	F. The vehicle should remain upright during and after collision although moderate roll, pitching and yawing are acceptable.	The vehicle remained upright and smoothly redirected. Maximum roll angle: 12.8 deg. Maximum pitch angle -4.4 deg.	Pass	
	H. Occupant impact velocities should satisfy the following:		Longitudinal 6.4 m/s Lateral 9.5 m/s	Pass
	Occupant Impact Velocities Limits [m/s]			
	Component Longitudinal and Lateral	Preferred 9 Maximum 12		
I. Occupant ridedown accelerations should satisfy the following:		Longitudinal 4.0 g Lateral 10.5 g	Pass	
Occupant Ridedown Accelerations Limits [G's]				
Component Longitudinal and Lateral	Preferred 15 Maximum 20			
Vehicle Trajectory	K. After collision is <i>preferable</i> that the vehicle's trajectory not intrude into adjacent traffic lanes.	Vehicle did not intrude into adjacent traffic lane	Pass	
	M. The exit angle from the test article <i>preferably</i> should be less than 60 percent of test impact angle, measured at time of vehicle loss of contact with test device.	Exit angle 17.5 deg., 70% of the impact angle.	Fail	



Time = 0.050 seconds

Time = 0.150 seconds

Time = 0.300 seconds

Time = 0.420 seconds

Barrier Type Modified ODOT GR-2.2 w/ rub-rail retrofit (post in concrete)

Vehicle Model

Type Modified NCAC C2500

Mass 2000 kg

Initial Conditions

Speed 100 km/hr

Angle 25 degrees

Exit Conditions

Speed 78.8 km/hr

Angle 17.5 degrees

Maximum Roll Angle 12.8 degrees

Maximum Pitch Angle 4.4 degrees

Vehicle Stability Acceptable

Occupant Impact Velocity

Longitudinal 6.4 < 12 m/s

Lateral 9.5

Occupant Ridedown Deceleration (g's)

Longitudinal 4.0 < 20 g's

Lateral 10.5

Maximum 50 ms Moving Average Acceleration (g's)

Longitudinal 10.4

Lateral 16.0

Vertical 2.4

THIV (m/s) 10.7

PHD (g's) 10.7

ASI 1.97

Figure 25: Summary of analysis results for Test 3-11 on modified rub-rail retrofit with posts in concrete foundation

Embedment of Posts in 3'-5" Soil

The vehicle model impacted the guardrail system 0.35 m downstream of post 1. Upon contact, the vehicle was traveling at 100 km/hr at an angle of 25 degrees with respect to the rail. The vehicle exited the system at approximately 0.420 seconds with an exit velocity of 80.4 km/hr at an angle of 14.3 degrees. The maximum roll and pitch angular displacements of the truck was -22.1 degrees (toward the guardrail) and -6.0 degrees (rear of vehicle pitches upward), respectively.

During impact the tire of the vehicle contacted the rub-rail and was successfully redirected, as shown in Figure 26, with little or no risk of direct impact with a post. A series of snapshots of the analysis corresponding to key events is shown in Figure 27: maximum guardrail deformation, vehicle parallel with guardrail, and vehicle exiting the system. The vehicle did experience moderate roll angle during redirection, however, vehicle stability was maintained in the simulation.

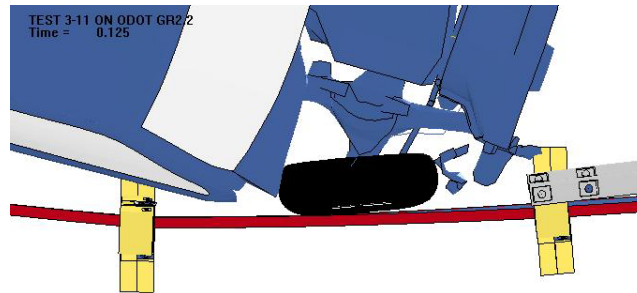

Figure 26: Wheel of vehicle successfully redirected by rub-rail

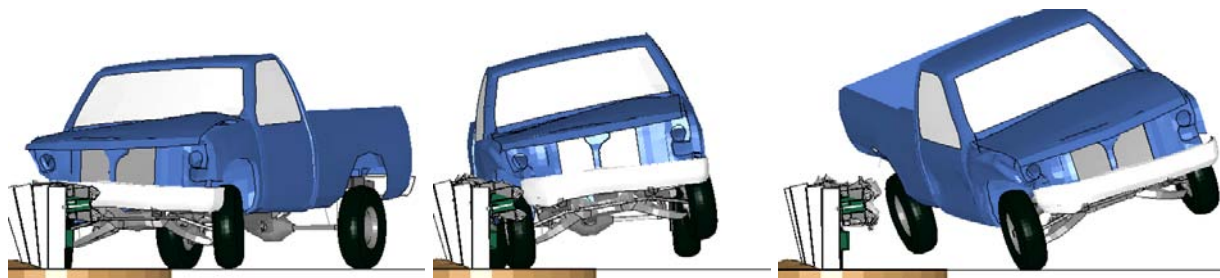

Figure 27: Sequential views of the simulated Test 3-11 impact event on the modified GR-2.2 with rub-rail (posts in soil)

The occupant impact velocity in the longitudinal direction was 4.5 m/s and the highest 0.010-second occupant longitudinal ridedown acceleration was -6.5 g. Table 7 and Figure 28 provide a summary of analysis results based on Report 350 evaluation criteria. More details of the F.E. analysis results are presented in Appendix 7.

Design 3: Nested W-Beam Retrofit

Design 3 was another retrofit solution to the GR-2.2 guardrail that entailed the simple modification of adding a w-beam rail element “nested” on top of the original w-beam rail. The nested w-beams provide adequate stiffness of the guardrail face to prevent the tires from pushing under the system. This solution is more attractive than the rub-rail retrofit because the rub-rail does not prevent the wheels from pushing underneath the w-beam where they would be exposed to the possibly of impacting the spacer blocks.

This design was evaluated for only one guardrail post mounting condition; the posts on either end of the GR-2.2 were embedded in 3’-5” of soil and the remaining posts of the GR-2.2 (the middle posts) were fully encased in concrete, as shown in the standard ODOT drawing of the GR-2.2 in Figure 29. The standard ODOT drawing of the GR-2.2 show the end posts embedded in a minimum of 3’-5” of soil for *ALL* installations, and thus the scenario of end posts in soil and middle posts fully encased in concrete is more representative of the upper bound stiffness of the GR-2.2 guardrail. The posts of the GR-3.4 transition were modeled as soil mounted.

End-Posts in Soil, Center Posts “Fixed” at Groundline

The vehicle model impacted the guardrail system 0.35 m downstream of post 1. Upon contact, the vehicle was traveling at 100 km/hr at an angle of 25 degrees with respect to the rail. The vehicle exited the system at approximately 0.340 seconds with an exit velocity of approximately 72 km/hr at an angle of 10.0 degrees. The maximum roll and pitch angular displacements of the truck was -23.0 degrees (toward the guardrail) and -9.0 degrees (rear of vehicle pitches upward), respectively.

During impact, the wheel was prevented from pushing underneath the rail. Figure 30 shows a comparison of the modified GR-2.2 with nested w-beam rails and the original GR-2.2 system,

illustrating the reduced potential for snagging. Table 8 and Figure 31 provide a summary of analysis results based on Report 350 evaluation criteria.

Table 7: Evaluation Criteria and Simulation Summary for Rub-Rail Retrofit with Posts in Soil Foundation - Test 3-11

Evaluation Factors	Evaluation Criteria	Test Results	Assessment	
Structural Adequacy	A. Test article should contain and redirect the vehicle; the vehicle should not penetrate, under-ride or over-ride the installation although controlled lateral deflection of the test article is acceptable.	Vehicle was contained and redirected	Pass	
Occupant Risk	D. Detached elements, fragments or other debris from the test article should not penetrate or show potential for penetrating the occupant compartment, or present an undue hazard to other traffic, pedestrians or other personnel in a work zone. Deformations of, or intrusions into, the occupant compartment that could cause serious injuries should not be permitted.	Not possible to evaluate since the vehicle model cannot reproduce failure or rupture of elements.	N. A.	
	F. The vehicle should remain upright during and after collision although moderate roll, pitching and yawing are acceptable.	The vehicle remained upright but showed moderate roll angle. Maximum roll angle: 22.1 deg. Maximum pitch angle -6.0 deg.	Pass	
	H. Occupant impact velocities should satisfy the following:		Longitudinal 4.5 m/s Lateral 6.3 m/s	Pass
	Occupant Impact Velocities Limits [m/s]			
	Component Longitudinal and Lateral	Preferred 9 Maximum 12		
I. Occupant ridedown accelerations should satisfy the following:		Longitudinal 6.5 g Lateral 10.6 g	Pass	
Occupant Ridedown Accelerations Limits [G's]				
Component Longitudinal and Lateral	Preferred 15 Maximum 20			
Vehicle Trajectory	K. After collision is <i>preferable</i> that the vehicle's trajectory not intrude into adjacent traffic lanes.	Vehicle did not intrude into adjacent traffic lane	Pass	
	M. The exit angle from the test article <i>preferably</i> should be less than 60 percent of test impact angle, measured at time of vehicle loss of contact with test device.	Exit angle 14.3 deg., 57% of the impact angle.	Pass	

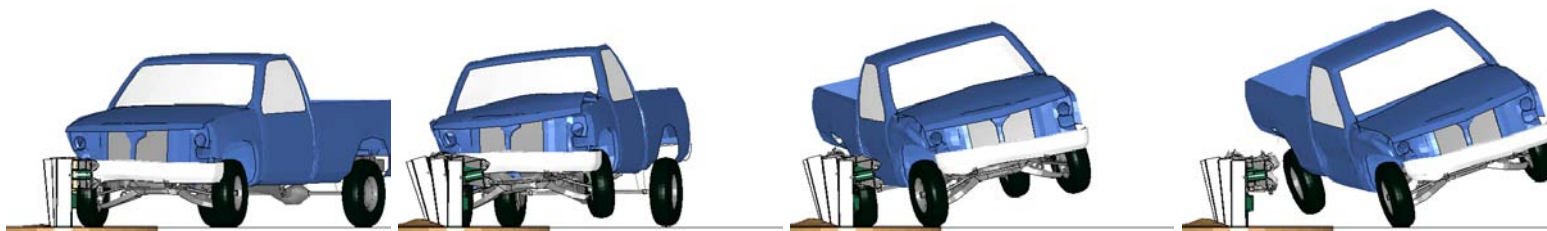

Time = 0.050 seconds

Time = 0.150 seconds

Time = 0.300 seconds

Time = 0.435 seconds

Barrier Type Modified ODOT GR-2.2 w/ rub-rail retrofit (post in soil)

Vehicle Model

Type Modified NCAC C2500

Mass 2000 kg

Initial Conditions

Speed 100 km/hr

Angle 25 degrees

Exit Conditions

Speed 80.4 km/hr

Angle 14.3 degrees

Maximum Roll Angle 22.1 degrees

Maximum Pitch Angle 6.0 degrees

Vehicle Stability Acceptable

Occupant Impact Velocity

Longitudinal 4.5 < 12 m/s

Lateral 6.3

Occupant Ridedown Deceleration (g's)

Longitudinal 6.5 < 20 g's

Lateral 10.6

Maximum 50 ms Moving Average Acceleration (g's)

Longitudinal 4.9

Lateral 8.1

Vertical 1.9

THIV (m/s) 7.1

PHD (g's) 11.4

ASI 0.96

Figure 28: Summary of analysis results for Test 3-11 on modified rub-rail retrofit with posts in soil foundation

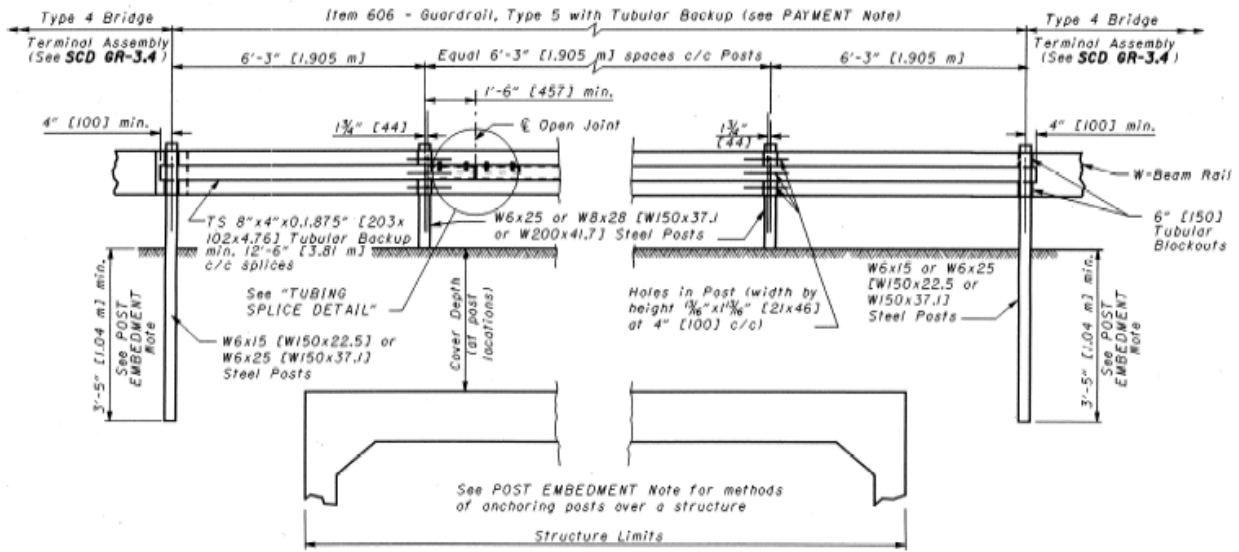

Figure 29: Standard drawing of the ODOT GR-2.2 Guardrail (see Appendix 1 for details)

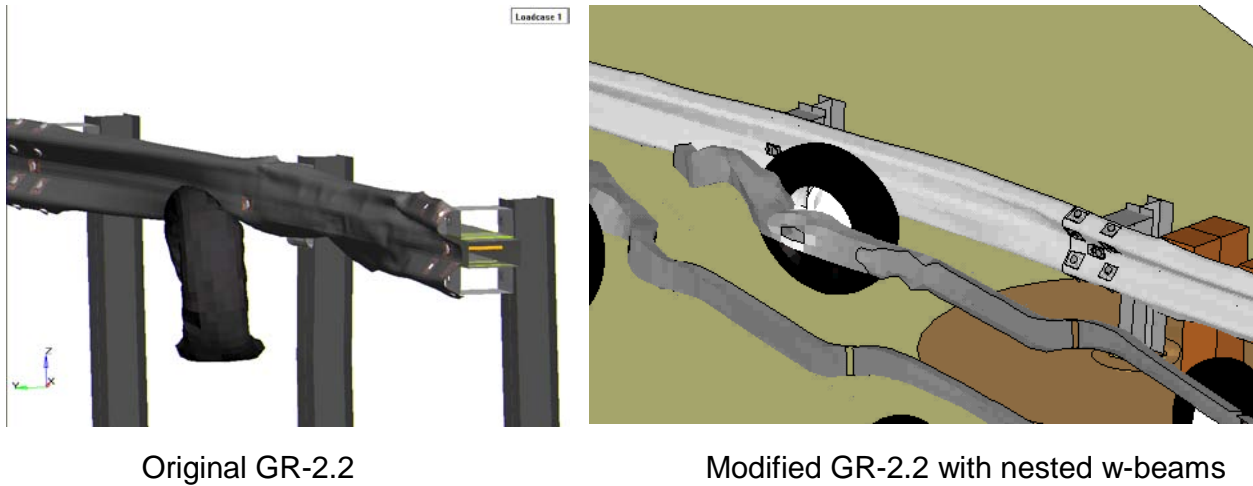
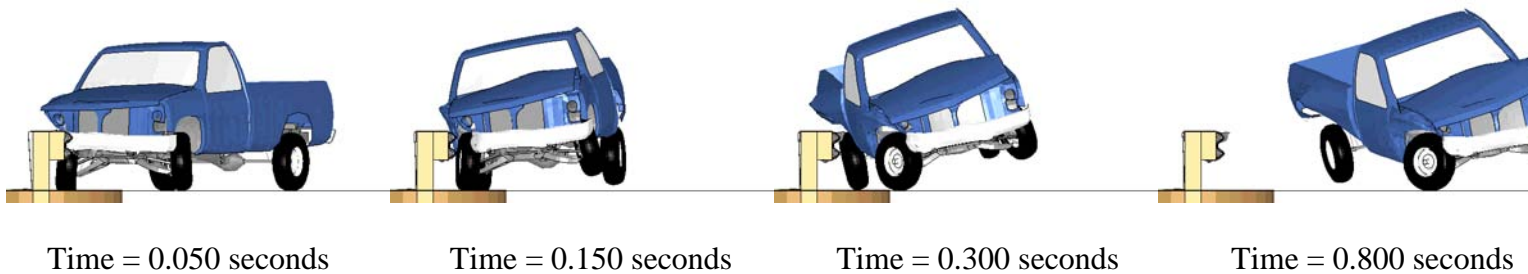

Figure 30: Comparison of the modified GR-2.2 with nested w-beam rails and the original GR-2.2 system, illustrating the reduced potential for snagging

Table 8: Evaluation Criteria and Simulation Summary for Nested W-Beam Retrofit - Test 3-11

Evaluation Factors	Evaluation Criteria	Test Results	Assessment	
Structural Adequacy	A. Test article should contain and redirect the vehicle; the vehicle should not penetrate, under-ride or over-ride the installation although controlled lateral deflection of the test article is acceptable.	Vehicle was contained and redirected	Pass	
Occupant Risk	D. Detached elements, fragments or other debris from the test article should not penetrate or show potential for penetrating the occupant compartment, or present an undue hazard to other traffic, pedestrians or other personnel in a work zone. Deformations of, or intrusions into, the occupant compartment that could cause serious injuries should not be permitted.	Not possible to evaluate since the vehicle model cannot reproduce failure or rupture of elements.	N. A.	
	F. The vehicle should remain upright during and after collision although moderate roll, pitching and yawing are acceptable.	The vehicle remained upright but showed moderate roll angle. Maximum roll angle: 23 deg. Maximum pitch angle -9.0 deg.	Pass	
	H. Occupant impact velocities should satisfy the following:		Longitudinal 6.5 m/s Lateral 9.1 m/s	Pass
	Occupant Impact Velocities Limits [m/s]			
	Component Longitudinal and Lateral	Preferred 9 Maximum 12		
	I. Occupant ridedown accelerations should satisfy the following:		Longitudinal 6.5 g Lateral 8.9 g	Pass
Occupant Ridedown Accelerations Limits [G's]				
Component Longitudinal and Lateral	Preferred 15 Maximum 20			
Vehicle Trajectory	K. After collision is <i>preferable</i> that the vehicle's trajectory not intrude into adjacent traffic lanes.	Vehicle did not intrude into adjacent traffic lane	Pass	
	M. The exit angle from the test article <i>preferably</i> should be less than 60 percent of test impact angle, measured at time of vehicle loss of contact with test device.	Exit angle 10.0 deg., 40% of the impact angle.	Pass	



Barrier Type Modified ODOT GR-2.2 w/ nested w-beam rail

Vehicle Model

Type Modified NCAC C2500
 Mass 2000 kg

Initial Conditions

Speed 100 km/hr
 Angle 25 degrees

Exit Conditions

Speed 78.0 km/hr
 Angle 10.0 degrees

Maximum Roll Angle 23.0 degrees

Maximum Pitch Angle 9.0 degrees

Vehicle Stability Acceptable

Occupant Impact Velocity

Longitudinal 6.5 < 12 m/s
 Lateral 9.1

Occupant Ridedown Deceleration (g's)

Longitudinal 6.5 < 20 g's
 Lateral 8.9

Maximum 50 ms Moving Average Acceleration (g's)

Longitudinal 10.6
 Lateral 15.6
 Vertical 2.5

THIV (m/s) 10.5

PHD (g's) 13.7

ASI 1.96

Figure 31: Summary of analysis results for Test 3-11 on nested w-beam retrofit with posts in soil foundation

Summary of Design Modification Results

The three modified systems that were evaluated (i.e., the two-tube system, the rub-rail retrofit and the nested w-beam retrofit), successfully prevented wheel contact with the guardrail posts and it is expected that the fourth modified system (i.e., the added tube through lower blockouts) would be successful as well. The increase in stiffness of these systems did not adversely affect the occupant risk measures and in each case the potential for wheel snag was significantly reduced. Tables 9 and 10 below show summaries of the occupant risk measurements computed from each analysis case.

Table 9: Occupant risk data computed using TRAP (posts in concrete).

Report 350 Criteria		Full-Concrete Encasement of Guardrail Posts			
		Original Design	Two-Tube Design	Rub-Rail Retrofit	Nested W-Beam Retrofit
Occupant Impact Velocity (OIV) (m/s)	Long.	6.5	5.9	6.4	6.5
	Trans.	9.1	9.3	9.5	9.1
Ridedown acceleration (g's)	Long.	6.2	5.6	4.0	6.5
	Trans.	8.4	11.6	10.5	8.9
50-ms average acceleration (g's)	Long.	10.5*	9.7*	10.4*	10.6*
	Trans.	15.6*	17.1*	16.0*	15.6*

* occur prior to occupant impact with the interior

Table 10: Occupant risk data computed using TRAP (posts in soil).

Report 350 Criteria		Guardrail Posts Embedded in 3'-5" Soil			
		Original Design	Two-Tube Design	Rub-Rail Retrofit	Nested W-Beam Retrofit
Occupant Impact Velocity (OIV) (m/s)	Long.	4.2	4.6	4.5	-
	Trans.	6.5	7.4	6.3	-
Ridedown acceleration (g's)	Long.	7.9	5.1	6.5	-
	Trans.	14.9	8.9	10.3	-
50-ms average acceleration (g's)	Long.	4.7	5.9	4.9	-
	Trans.	8.1	9.8	8.1	-

PHASE II - EVALUATION AND REDESIGN OF THE ODOT GR-3.4 TRANSITION

When a relatively flexible longitudinal barrier is connected to a stiffer barrier, the abrupt change in stiffness at the connection may lead to vehicular pocketing, snagging and/or penetration of the system. A transition guardrail section is, therefore, often used to produce a gradual stiffening between the two barrier systems. There are several transition designsⁱⁱ that have been approved for use on the National Highway System (NHS). These systems are generally designed to transition from a semi-rigid guardrail such as a strong-post guardrail system to a rigid bridge rail or other rigid abutment. For these cases, the transition is required to be very rigid as it nears the attachment point to the rigid barrier.

The current transition system used to connect the ODOT GR-2.2 guardrail to the ODOT Type 5 guardrail (strong-post guardrail system) is the ODOT GR-3.4 (ODOT Bridge Terminal Assembly Type 4), shown in Figures 32 and 33 (refer to Appendix 1 for detailed drawings). This transition was not approved as a TL-3 system for general use as a transition to a rigid barrier. Unlike most rigid barriers, the GR-2.2 has a range of stiffness values depending on the mounting conditions of the guardrail posts, as discussed in Phase 1. It was decided by the research team that none of the current FHWA approved TL-3 transition systems would likely be compatible with the GR-2.2 because of their relatively high lateral stiffness. For example, in cases where the posts of the GR-2.2 are embedded in concrete, the guardrail is very stiff - similar to a bridge rail system. On the other hand, where there is sufficient soil cover over a culvert, the posts of the GR-2.2 will be embedded in soil with no attachment to the culvert, resulting in a more flexible system. All other post mounting conditions used in the system result in guardrail stiffnesses that are somewhere between these two bounding cases. Thus, it is necessary to determine if the current system is compatible with the GR-2.2 guardrail over a wide range of guardrail stiffness levels.

A critical impact scenario that must be considered when evaluating the GR-2.2 is an impact on the downstream end of the guardrail at the connection to the transition system. For the case of a

ⁱⁱ Approved TL-3 transition systems listed on the FHWA website at:
http://safety.fhwa.dot.gov/roadway_dept/road_hardware/longbarriers.htm

non-rigid mounting condition of the GR-2.2 (e.g., posts embedded in soil), the GR-2.2 may be less stiff than the transition and pocketing may occur, causing the vehicle to snag at the connection point of the transition.

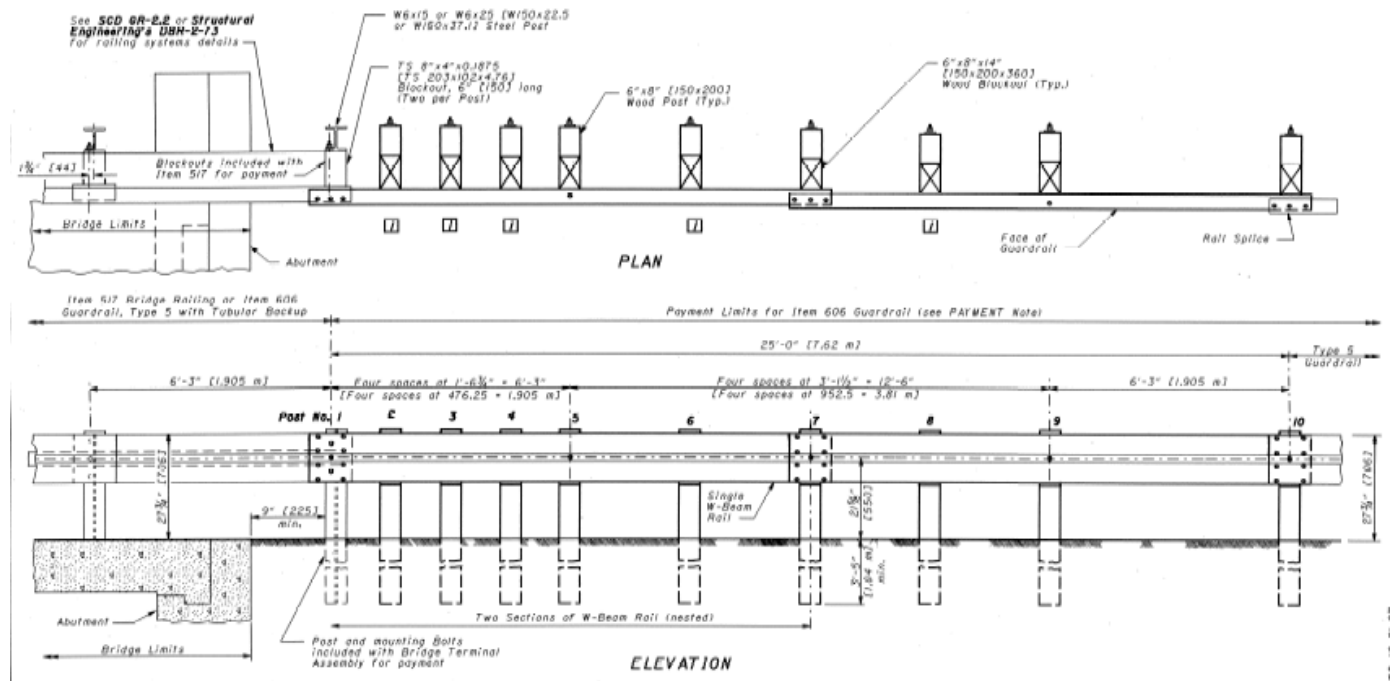

Figure 32: Standard drawing of the ODOT GR-3.4 (see Appendix 1 for details)



Figure 33: Photo of the ODOT GR-2.2 guardrail and ODOT GR-3.4 transition at a site along HW 315 north of Columbus, Ohio.

It should be noted that the ODOT Bridge Terminal Assembly Type 4 (GR-3.4) is the same system as the MBGF (T101), which is the transition system used with the Texas T101 bridge rail – it is our understanding that the MBGF (T101) has only been approved as a TL 3 transition for

use with the Texas T101 bridge rail. The T101 is very similar to the ODOT GR-2.2 (refer to discussion in Phase I) which indicated to the research team that this transition may also be compatible with the GR-2.2.

The research approach taken for Phase II was to:

- Evaluate the performance of the ODOT GR-3.4 (ODOT Bridge Terminal Assembly Type 4) for use with the ODOT GR-2.2 (ODOT Type 5 Tubular Backup Guardrail) with rub-rail and determine if it qualifies as an NCHRP Report 350 TL-3 system
- Identify any weaknesses of the system that may affect its performance
- Identify other TL-3 transitions that may work effectively with the GR-2.2 or propose any changes to the current system that will result in improved performance

ANALYSIS OF THE ODOT GR-3.4 TRANSITION

Six impact conditions were considered and five were selected for further evaluation:

- 1) GR-2.2 with posts in soil
 - a. Impact on transition at approximately 1.5 m upstream of barrier
- 2) GR-2.2 with posts “fixed” at groundline (concrete encased) (**Critical**)
 - a. Impact on transition at approximately 1.5 m upstream of barrier
- 3) GR-2.2 with posts in soil (**Critical**)
 - a. Impact on GR-2.2 at approximately 1.3 m upstream of transition
- 4) (**Analysis not conducted**) - GR-2.2 with posts “fixed” at groundline (concrete encased)
 - a. Impact on GR-2.2 at approximately 1.3 m upstream of transition

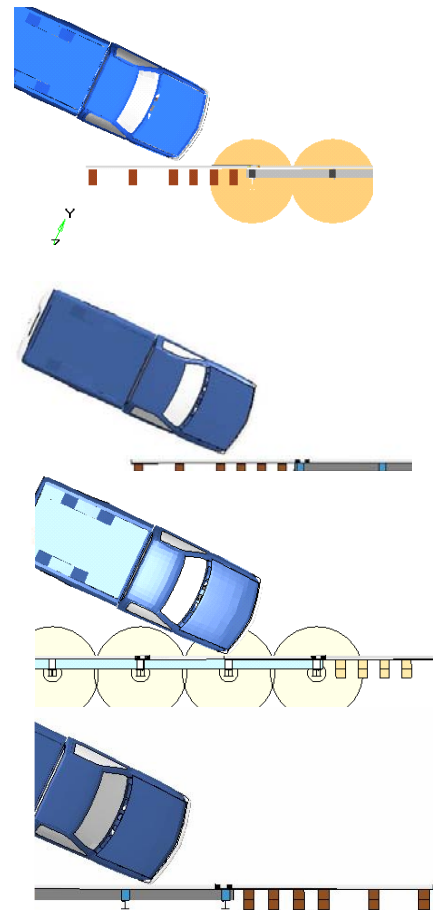

- 5) GR-2.2 with **end-posts in soil, center posts “fixed” at groundline (concrete encased) (Critical)**
 - a. Impact on Transition at approx. 1.5 m upstream of transition

- 6) GR-2.2 with **end-posts in soil, center posts “fixed” at groundline (concrete encased)**
 - a. Impact on GR-2.2 at approximately 1.3 m upstream of transition

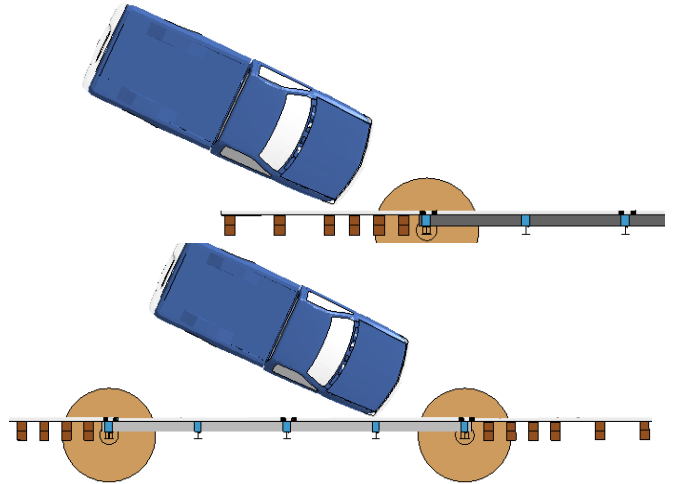

Cases 2 and 3 were considered critical cases for the combination of the transition system with the GR-2.2. In case 2 the vehicle is impacting on the transition (somewhat flexible) and is approaching a very stiff GR-2.2 which may result in “pocketing” and subsequent snagging on the guardrail end. Case 3 is a similar scenario where the vehicle impacts the flexible GR-2.2 (with posts in soil) and approaches the relatively stiff transition section which may result in “pocketing” and subsequent snagging on the end of the transition.

Cases 2 and 3 represent the two extreme conditions of guardrail stiffness (i.e., all posts embedded in concrete) and if the transition and guardrail are compatible in these two cases then they should be compatible in all post mounting conditions of the GR-2.2 guardrail. The results of Cases 2 and 3 also will provide some insight regarding how the system may performance when used in Bridge Rail application. Recall that the GR-2.2 was derived from the Ohio Box Beam Bridge Rail. Although the bridge rail is no longer being installed, there are a large number of old installations still in service.

A more representative upper bound of the stiffness of the GR-2.2 is evaluated in cases 5 and 6, where the end posts are embedded in soil and the center posts are embedded in concrete. The standard ODOT drawing of the GR-2.2 (refer to Figure 29) show the end posts embedded in a minimum of 3’-5” of soil for *ALL* installations. Case 5 is more representative of the scenario of vehicle impact on the transition, approaching the guardrail (e.g., compared to case 2). Similarly,

Case 6 is more representative of the scenario of vehicle impact on the guardrail, approaching the transition section (e.g., compared to Case 4).

Case 1 and Case 2

Cases 1 and 2 both involve the vehicle impacting on the transition system at approximately 1.5 m upstream of the GR-2.2 guardrail. In case 1, the GR-2.2 guardrail posts are mounted in 3'-5" of soil, and in case 2, the posts are fully constrained at the groundline to simulate full concrete encasement of the posts. Figure 34 below shows sequential views of the F.E. analysis results of cases 1 and 2 from an overhead view. In case 1, both the transition and the guardrail deflect approximately the same amount and the vehicle is redirected very smoothly. In case 2, there is some pocketing as the posts of the transition deflect during impact while the guardrail remains rigid, however, the vehicle continues to redirect with only minimal snagging.

Occupant risk measures were computed using the results of the analysis and the software TRAP and are provided below in Table 11. The acceleration-time history computed at the center of gravity (c.g.) of the vehicle is shown in Figure 35.

CASE 1

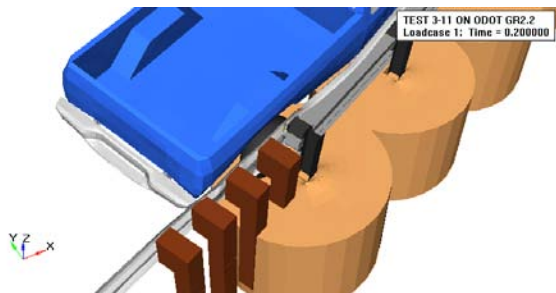
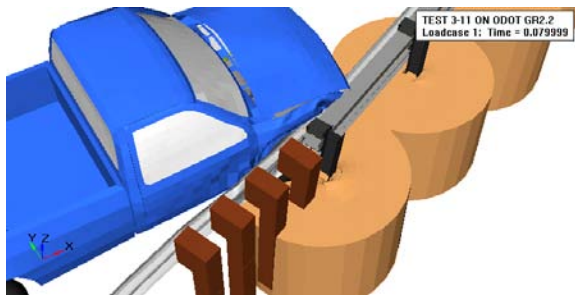
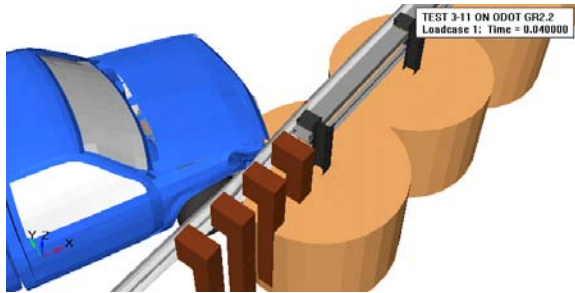
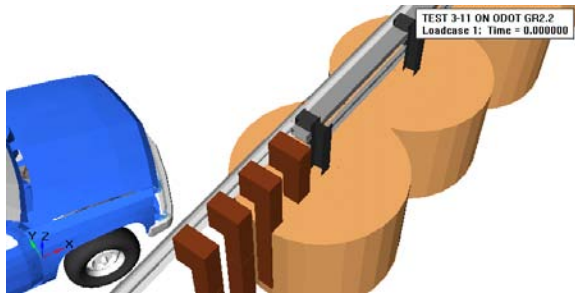

CASE 2

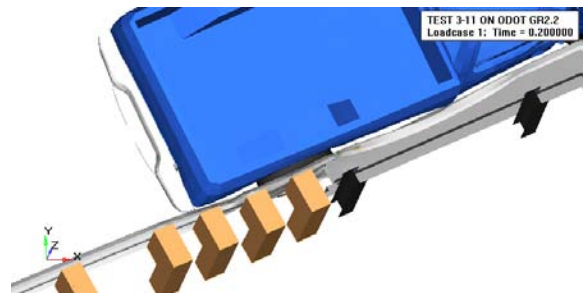
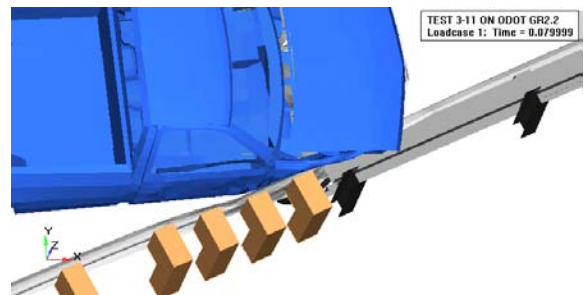
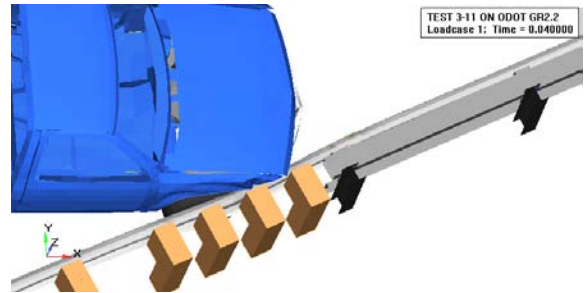
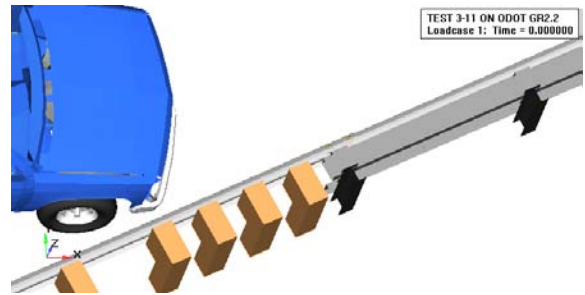

Figure 34: Sequential views of the NCHRP Report 350 Test 3-11 analysis of the ODOT Bridge Terminal Assembly Type 4 and GR-2.2 Guardrail for Cases 1 and 2.

Table 11: Occupant risk values computed using the software TRAP for Case 2

Occupant Risk Factors			
Impact Velocity (m/s) at 0.0921 seconds on right side of interior			
x-direction	6.2		
y-direction	10.0		
Ridedown Accelerations (g's)			
x-direction	-9.1	(0.0989 - 0.1089 seconds)	
y-direction	-8.5	(0.2118 - 0.2218 seconds)	
THIV (km/hr):	40.0	at 0.0907 seconds on right side of interior	
THIV (m/s):	11.1		
PHD (g's):	12.7	(0.1066 - 0.1166 seconds)	
ASI:	2.17	(0.0359 - 0.0859 seconds)	

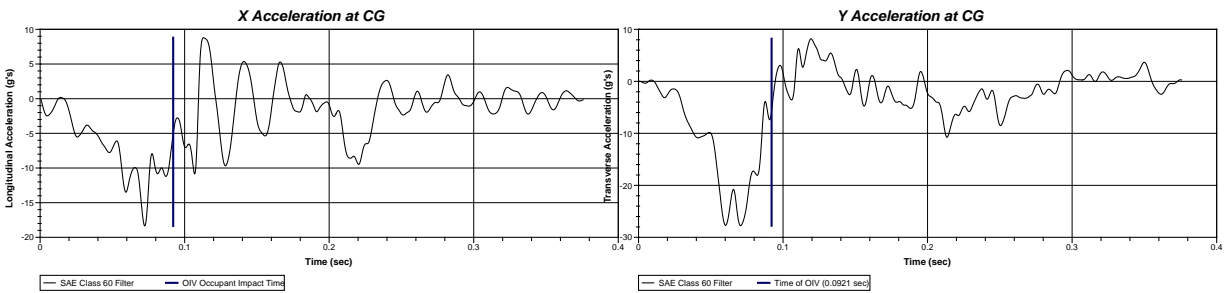

Figure 35 :Acceleration-time histories computed at the c.g. of the vehicle during Test 3-11 impact analysis of the ODOT Bridge Terminal Assembly Type 4 and GR-2.2 Guardrail for Case 2.

Case 3

In Case 3, the posts of the GR-2.2 are embedded in soil and the pickup truck impacts the system on the GR-2.2 at approximately 1.5 m upstream of the transition. The critical scenario in this case is pocketing of the system at the connection of the GR-2.2 guardrail and the GR-3.4 transition.

Two different soil conditions were considered in this case:

- **Representative case:** where the soil properties are the same for both the guardrail and transition and are representative of NCHRP Report 350 standard soil.
- **Conservative case:** where the guardrail soil is less stiff than transition soil
 - Soil for guardrail model is more representative of Report 350 weak soil
 - Soil for transition model is representative of Report 350 standard soil

Figure 36 below shows sequential views of the results of case 3 for both the representative case and the conservative case from an overhead view. In both cases there was notable snagging of the impact-side front wheel as the wheel passed across the connection of the GR-2.2 and the GR-3.4. The snag of the wheel was more prevalent in the conservative case and resulted in a high longitudinal ridedown acceleration of 18.2 g's.

Time = 0.050 seconds

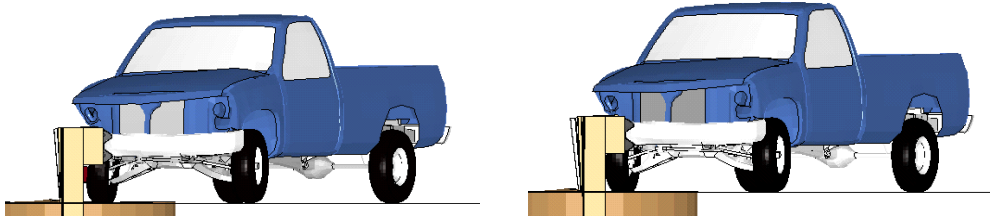

Time = 0.100 seconds

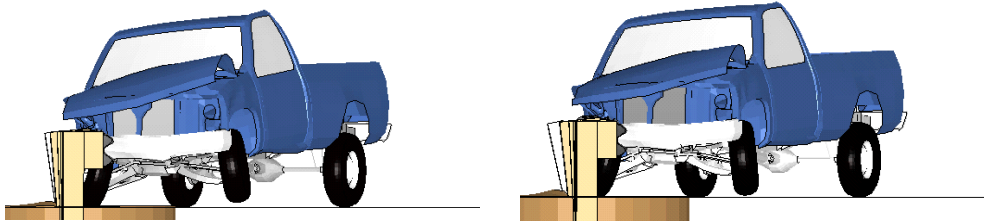

Time = 0.150 seconds

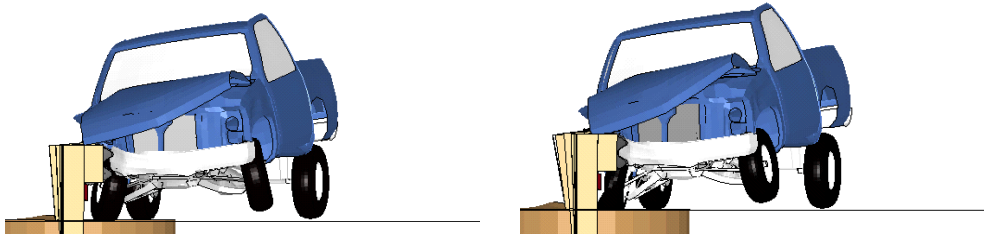

Time = 0.200 seconds

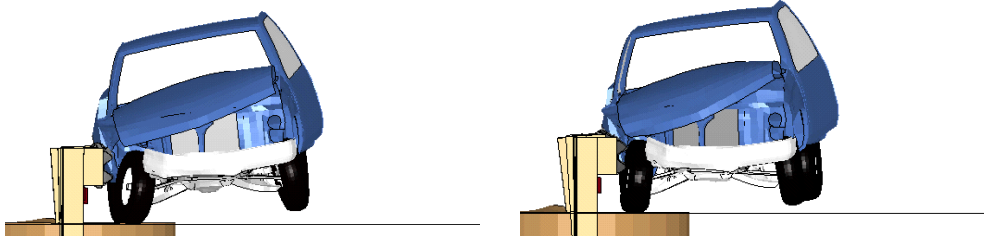

Time = 0.600 seconds

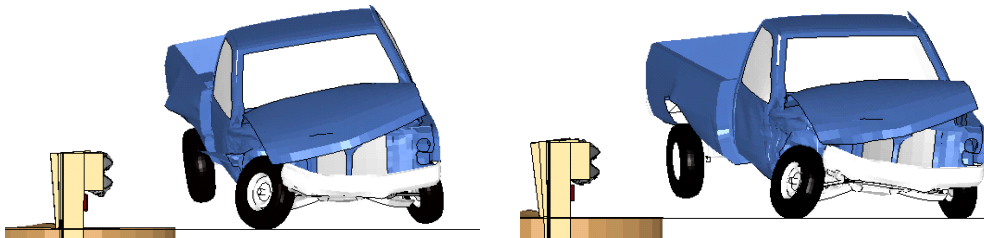

Representative Case

Conservative Case

Figure 36 :Sequential views of the NCHRP Report 350 Test 3-11 analysis of the ODOT Bridge Terminal Assembly Type 4 and GR-2.2 Guardrail for Case 3.

A summary of Occupant risk measures were computed and are provided below in Table 12 and Table 13 for the Representative Case and the Conservative Case, respectively. The acceleration-time histories for the two cases are shown in Figures 37 and 38.

Table 12: Occupant risk values computed using the software TRAP for Case 3 – Representative Case

Occupant Risk Factors		
Impact Velocity (m/s)		at 0.1034 seconds on right side of interior
x-direction	7.8	
y-direction	8.6	
Ridedown Accelerations (g's)		
x-direction	-14.0	(0.1199 - 0.1299 seconds)
y-direction	-11.7	(0.1090 - 0.1190 seconds)
THIV (km/hr):	38.6	at 0.1005 seconds on right side of interior
THIV (m/s):	10.7	
PHD (g's):	16.4	(0.1160 - 0.1260 seconds)
ASI:	1.63	(0.0518 - 0.1018 seconds)

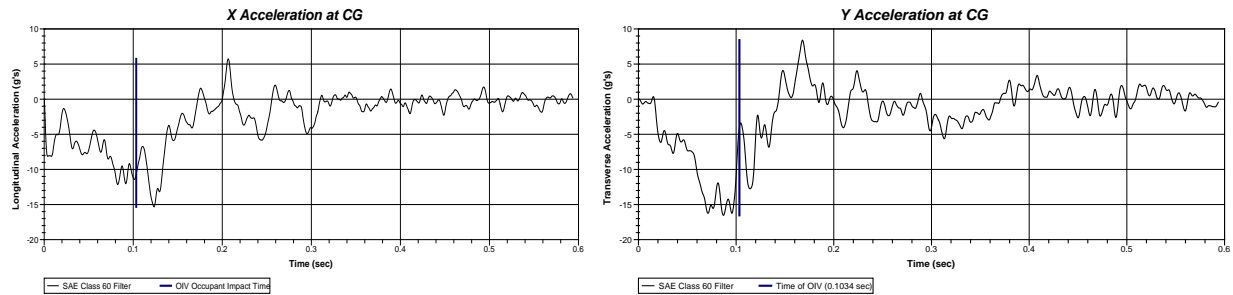

Figure 37 :Acceleration-time histories computed at the c.g. of the vehicle during Test 3-11 impact analysis of the ODOT Bridge Terminal Assembly Type 4 and GR-2.2 Guardrail for Case 3 – Representative Case.

Table 13: Occupant risk values computed using the software TRAP for Case 3 – Conservative Case

Occupant Risk Factors		
Impact Velocity (m/s) at 0.1101 seconds on right side of interior		
x-direction	7.6	
y-direction	8.3	
Ridedown Accelerations (g's)		
x-direction	-18.2	(0.1141 - 0.124 seconds)
y-direction	-11.6	(0.1101 - 0.1201 seconds)
THIV (km/hr):	36.5	at 0.1064 seconds on right side of interior
THIV (m/s):	10.1	
PHD (g's):	21.0	(0.1127 - 0.1227 seconds)
ASI:	1.66	(0.0699 - 0.1199 seconds)

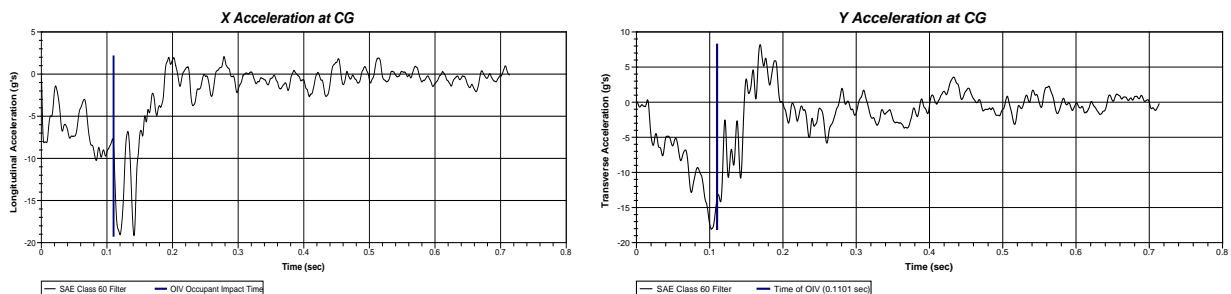

Figure 38 :Acceleration-time histories computed at the c.g. of the vehicle during Test 3-11 impact analysis of the ODOT Bridge Terminal Assembly Type 4 and GR-2.2 Guardrail for Case 3 – Conservative Case.

Case 4

In Case 4, the vehicle impacts on the GR-2.2 (with posts embedded in concrete) at approximately 1.5 m upstream of the GR-3.4 transition. Since the impacting vehicle moves from a stiff barrier to a less stiff barrier, Case 4 was not considered to be a critical impact scenario and therefore an analysis was not conducted.

Case 5

In Case 5 and Case 6, the GR-2.2 is modeled with post mounting conditions that represent the most stiff mounting conditions that would be expected for the GR-2.2 (refer to Figure 29). The

posts of the GR-2.2 located over the culvert are embedded in concrete and are modeled with fixed boundary conditions. The two end posts of the GR-2.2 are embedded in soil. In Case 5, the vehicle model impacts the system on the GR-3.4 transition at approximately 1.5 m upstream of the GR-2.2 guardrail. Figure 39 below shows sequential views of the results of case 5 from a downstream view point and an overhead “tight” view.

The wheel of the vehicle smoothly passed across the connection of the GR-2.2 and the GR-3.4 with no apparent likelihood of wheel snag. A summary of Occupant risk measures were computed and are provided below in Table 14 and the acceleration-time histories are shown in Figure 40.

Time = 0.050 seconds

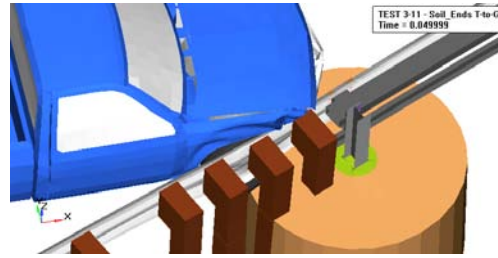

Time = 0.150 seconds

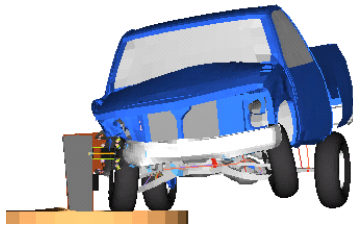

Time = 0.200 seconds

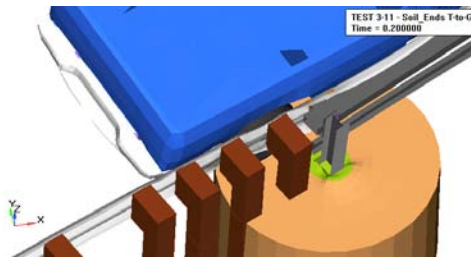
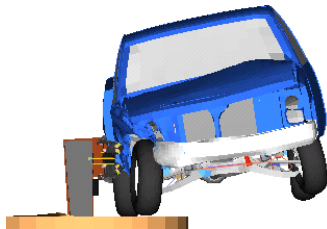

Time = 0.250 seconds

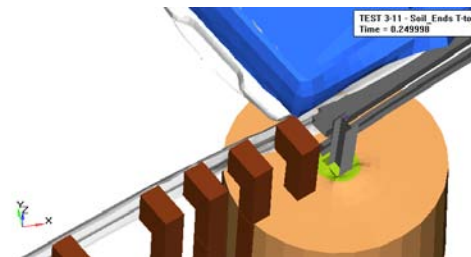
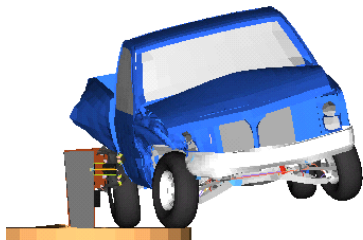

Time 0.800 seconds

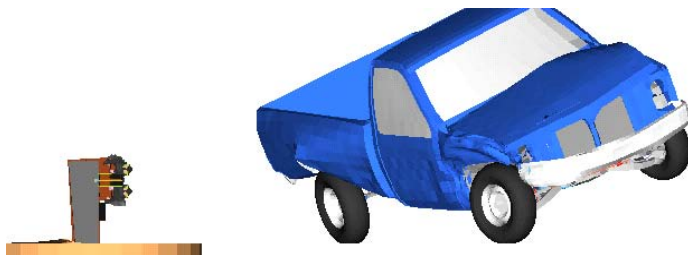

Figure 39: Sequential views of the NCHRP Report 350 Test 3-11 analysis of the ODOT Bridge Terminal Assembly Type 4 and GR-2.2 Guardrail for Case 5.

Table 14: Occupant risk values computed using the software TRAP for Case 5

Occupant Risk Factors		
Impact Velocity (m/s)		at 0.0973 seconds on right side of interior
x-direction	6.2	
y-direction	8.1	
Ridedown Accelerations (g's)		
x-direction	-8.6	(0.1191 - 0.1291 seconds)
y-direction	-8.8	(0.2329 - 0.2429 seconds)
THIV (km/hr):	34.5	at 0.0956 seconds on right side of interior
THIV (m/s):	9.6	
PHD (g's):	10.7	(0.2303 - 0.2403 seconds)
ASI:	1.71	(0.0383 - 0.0883 seconds)

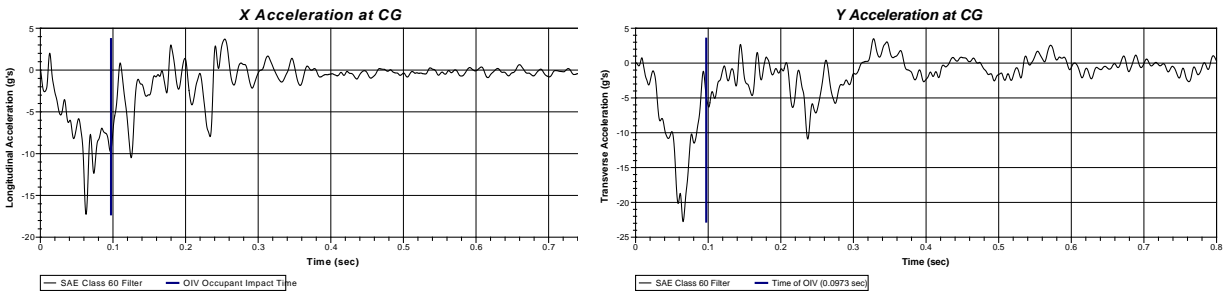
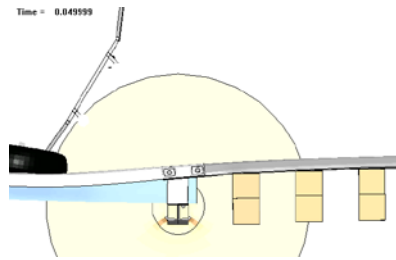
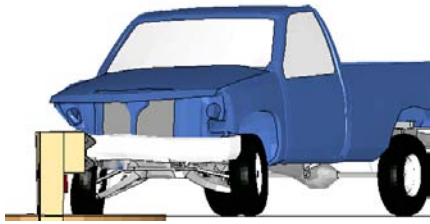

Figure 40: Acceleration-time histories computed at the c.g. of the vehicle during Test 3-11 impact analysis of the ODOT Bridge Terminal Assembly Type 4 and GR-2.2 Guardrail for Case 5.

Case 6

In Case 6, as in Case 5, the posts of the GR-2.2 located over the culvert are embedded in concrete and are modeled with fixed boundary conditions. The two end posts of the GR-2.2 are embedded in soil. The vehicle model impacts the system on the GR-2.2 guardrail at approximately 1.5 m upstream of the GR-3.4 transition connection. Figure 41 below shows sequential views of the results of case 6 from a downstream view point and an overhead view (of wheel only).

Time = 0.050 seconds



Time = 0.100 seconds

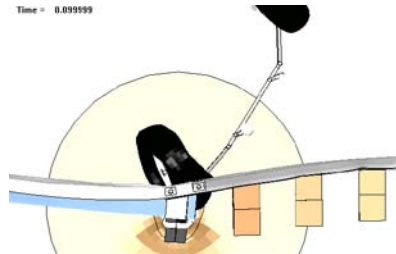
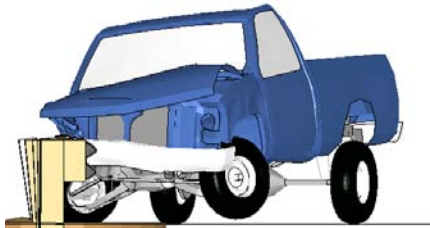

Time = 0.150 seconds

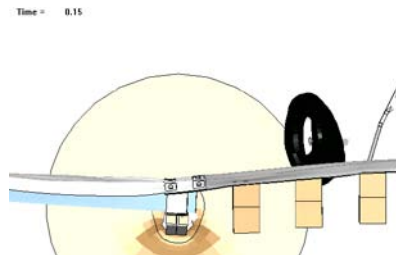
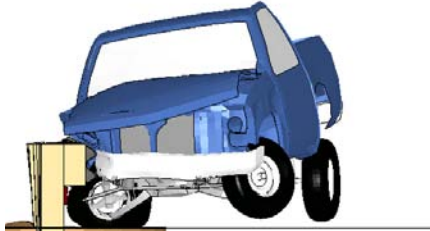

Time = 0.200 seconds

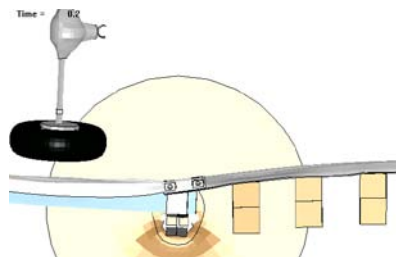
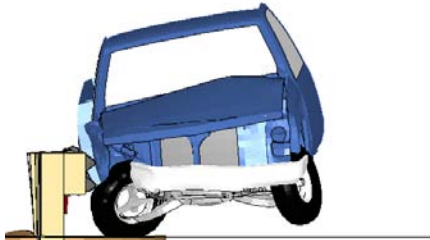

Time = 0.250 seconds

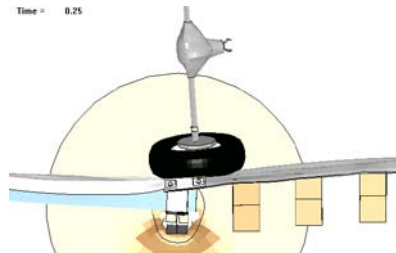
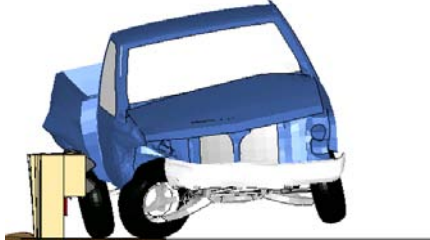

Figure 41: Sequential views of the NCHRP Report 350 Test 3-11 analysis of the ODOT Bridge Terminal Assembly Type 4 and GR-2.2 Guardrail for Case 6.

During impact, the wheel pushes underneath the rail and snags on the lower spacer tube. Although the ride-down accelerations were within the limits required by NCHRP Report 350, they were relatively high and could be reduced by preventing the wheel snag that occurred at the splice connection. A summary of Occupant risk measures were computed and are provided below in Table 15 and the acceleration-time histories are shown in Figure 42.

Table 15: Occupant risk values computed using the software TRAP for Case 6

Occupant Risk Factors		
Impact Velocity (m/s)		at 0.0947 seconds on right side of interior
x-direction	6.4	
y-direction	7.6	
Ridedown Accelerations (g's)		
x-direction	-13.1	(0.0988 - 0.1088 seconds)
y-direction	-15.6	(0.1031 - 0.1131 seconds)
THIV (km/hr):	34.0	at 0.0925 seconds on right side of interior
THIV (m/s):	9.4	
PHD (g's):	19.9	(0.1030 - 0.1130 seconds)
ASI:	1.51	(0.0393 - 0.0893 seconds)

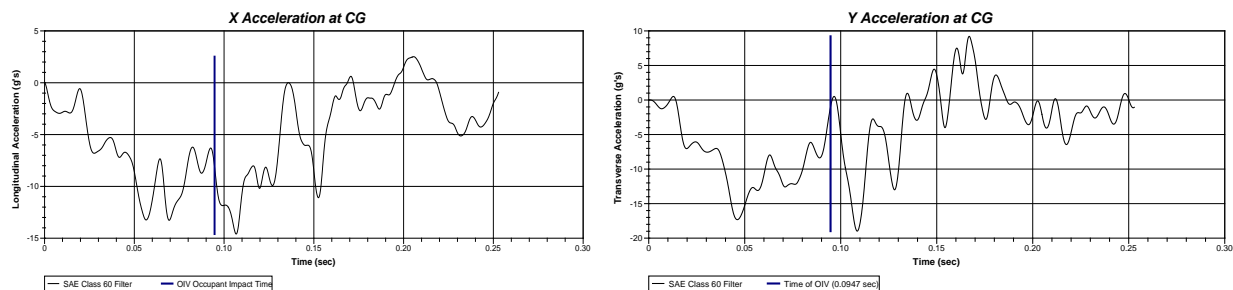

Figure 42: Acceleration-time histories computed at the c.g. of the vehicle during Test 3-11 impact analysis of the ODOT Bridge Terminal Assembly Type 4 and GR-2.2 Guardrail for Case 6.

A summary of occupant risk factors and vehicle maximum roll and pitch angles for Cases 2, 3, 5 and 6 are presented below in Table 16. The terms T2G and G2T in Table 16 are used to denote the two impact locations of the vehicle in the analyses; impact on the upstream transition approaching the upstream end of the guardrail is denoted by T2G; impact on the downstream end of the guardrail approaching the downstream transition is denoted by G2T.

Table 16: Summary of Occupant Risk Factors and Vehicle Maximum Roll and Pitch Angles for Cases 2, 3, 5, and 6.

Occupant Risk Measure	Case 2	Case 3		Case 5	Case 6	
	Concrete Mounting T2G	Soil Mounting G2T		Soil Mounted End Posts T2G	Soil Mounted End Posts G2T	
		Weak Soil	Standard Soil		Weak Soil	Standard Soil
Long – OIV (m/s)	6.2	7.6	7.8	6.2	6.4	-
Trans – OIV (m/s)	10.0	8.3	8.6	8.1	7.6	-
Long-ridedown acceleration (g)	9.1	18.2	14.0	8.6	13.1	-
Trans-ridedown acceleration (g)	8.5	11.6	11.7	8.8	15.6	-
Roll (deg)	16.3	12.7	17.5	26.0	-	-
Pitch (deg)	6.3	7.9	11.2	6.9	-	-

DESIGN OF TRANSITION TO BE COMPATIBLE WITH THE GR-2.2

The most notable problem with the current system was related to the *stiffness discontinuity* at the *connection* of the GR-2.2 guardrail and the GR-3.4 transition. Figure 43 illustrates this problem where the wheel of the vehicle pushes the bottom of the w-beam (*single layer*) inward as it approaches the splice connection (*triple layer*) of the GR-2.2 and the Transition.

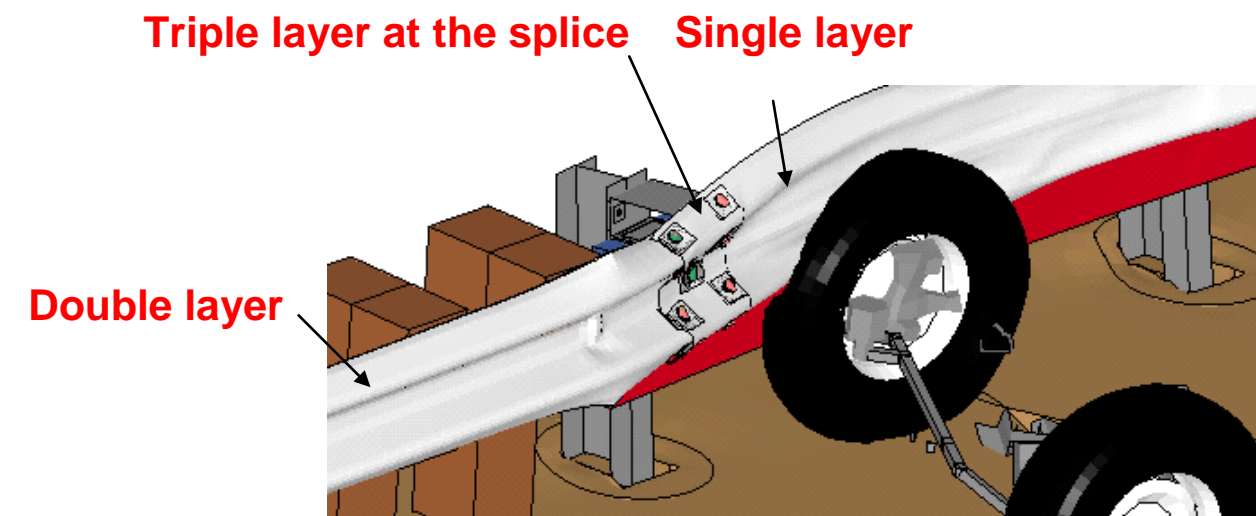

Figure 43: Analysis results illustrating cause of wheel snag at the splice connection of the GR-2.2 and GR-3.4.

Modification A – Modified Connection with Staggered W-Beam Rails

One solution to this problem was to modify both the GR-2.2 and the GR-3.4 by using a “staggered” arrangement of the nested w-beam across the splice connection, as shown in the series of figures in Figure 44. Figure 44 illustrates the arrangement of w-beam rails across the splice connection. The result is a system with no abrupt change in stiffness, as illustrated in Figure 45.

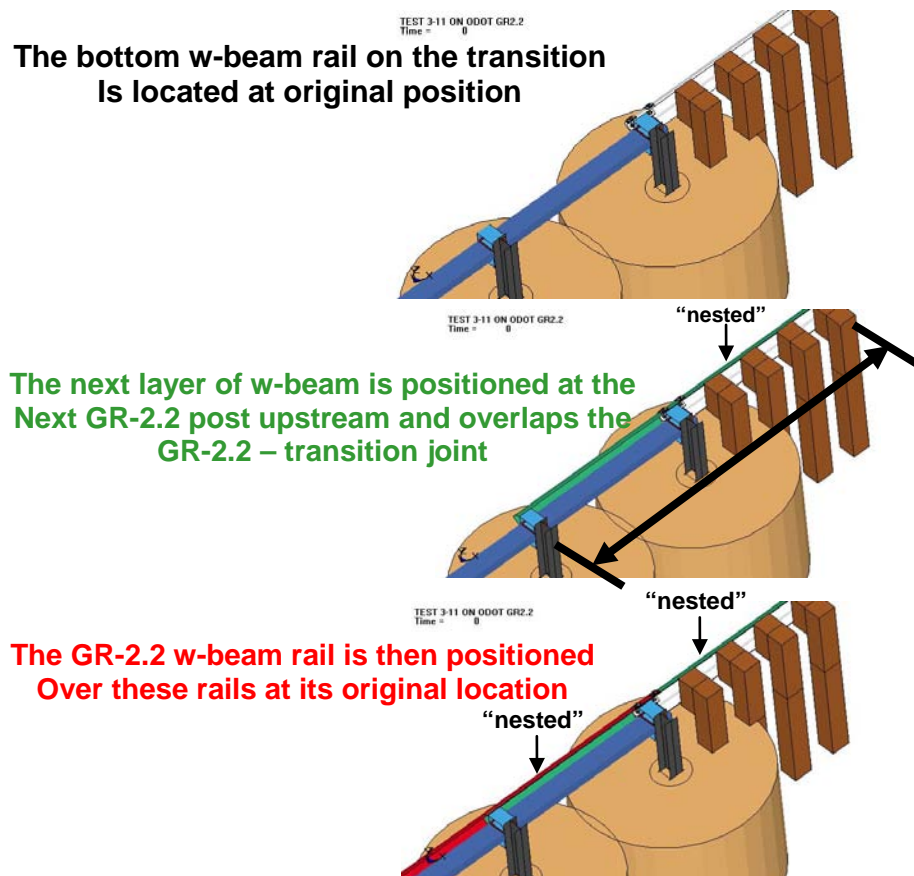

Figure 44: Modified “staggered” rail GR-2.2 and GR-3.4 system to minimize stiffness discontinuity across splice connection.

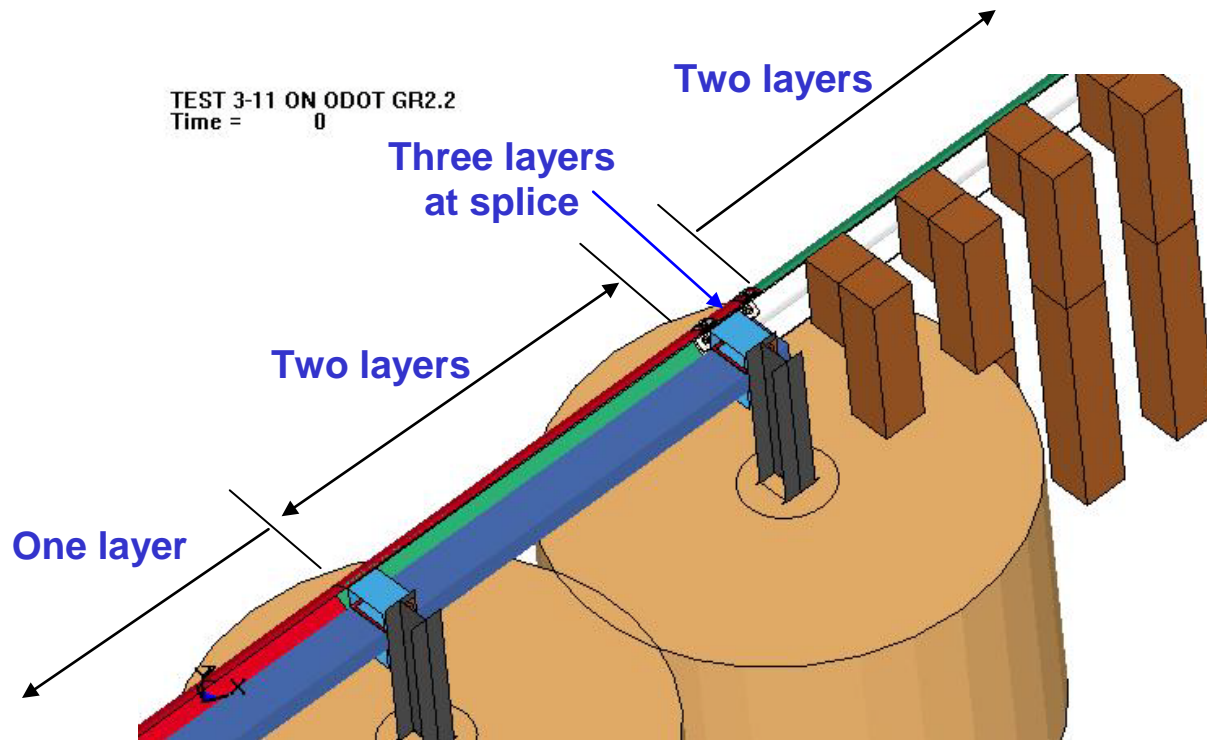

Figure 45: Modified “staggered” rail GR-2.2 and GR-3.4 system to minimize stiffness discontinuity across splice connection.

Case 3 and Case 6 were re-evaluated using the modified system and the results of those analyses are compared to the results of the unmodified system in Tables 17 and 18. The ride-down accelerations were significantly reduced in Report 350 Test 3-11 impact with the modified system compared to the original system (i.e., from 18.2 g to 8.7 g for weak soil case). The modification to the system was sufficient to eliminate the potential for wheel snag, which is clearly illustrated in figures 46 and 47 for Cases 3 and 5, respectively.

Table 17: Summary of results comparing “staggered” rail system to the original system for impact scenario Case 3.

Occupant Risk Measure	Case 3 Soil G2T			
	original splice connection		w/staggered rail	
	Weak Soil	Standard Soil	Weak Soil	Standard Soil
Long – OIV (m/s)	7.6	7.8	7.0	7.3
Trans – OIV (m/s)	8.3	8.6	7.8	8.5
Long-ridedown acceleration (g)	18.2	14.0	8.7	6.2
Trans-ridedown acceleration (g)	11.6	11.7	8.8	5.9
Roll (deg)	12.7	17.5	-	20.3
Pitch (deg)	7.9	11.2	-	8.3

TEST 3-11 ON ODOT GR2.2
Time = 0.13

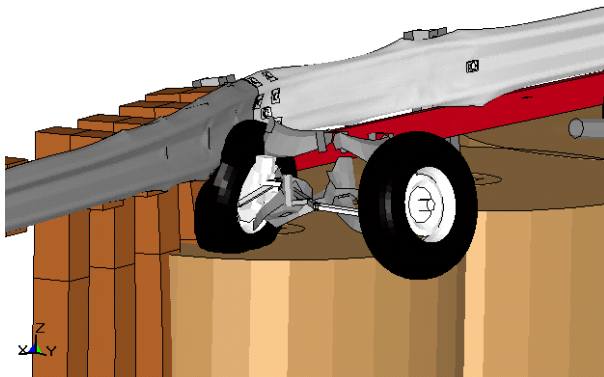

Original Splice Connection

TEST 3-11 ON ODOT GR2.2
Time = 0.13

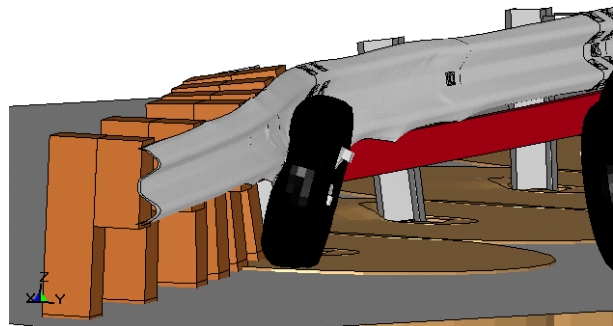

Modified Splice Connection

Figure 46: Results of modified “staggered” rail system compared to results of original system for case 3, illustrating reduced potential for wheel snag.

Table 18: Summary of results comparing “staggered” rail system to the original system for impact scenario Case 6.

Occupant Risk Measure	Case 6 Soil Ends G2T			
	original splice connection		w/staggered rail	
	Weak Soil	Standard Soil	Weak Soil	Standard Soil
Long – OIV (m/s)	6.4	-	6.6	-
Trans – OIV (m/s)	7.6	-	7.9	-
Long-ridedown acceleration (g)	13.1	-	9.1	-
Trans-ridedown acceleration (g)	15.6	-	6.3	-
Roll (deg)	-	-	25.2	-
Pitch (deg)	-	-	6.9	-

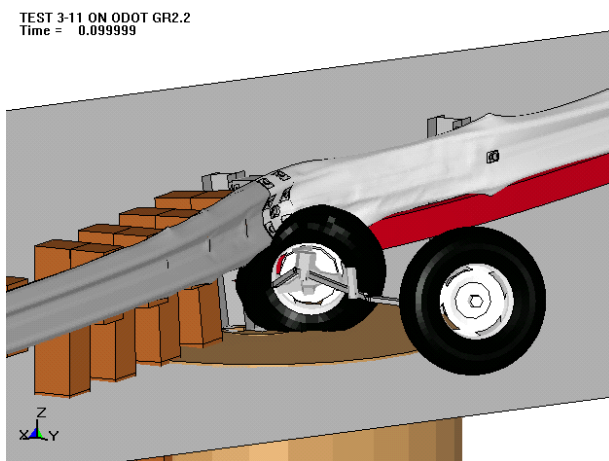

Original Splice Connection

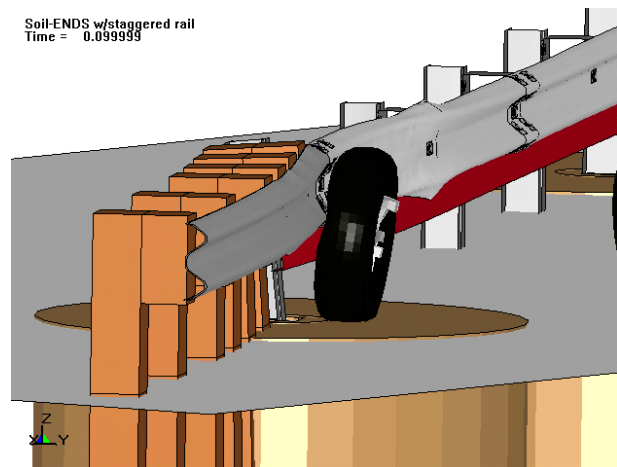

Modified Splice Connection

Figure 47: Results of modified “staggered” rail system compared to results of original system for case 6, illustrating reduced potential for wheel snag.

Although the modification of the splice connection of using a “staggered” rail approach results in a significant performance enhancement of the system, it is not a very feasible solution to the problem. In order to install the staggered rail, additional splice holes would be required at the center-span of the w-beam rails. A more feasible solution is presented in Modification B.

Modification B – Modified GR-2.2 with Nested W-Beam Rails

Recall from Phase I that the performance of the GR-2.2 was critically evaluated. It was determined that the system would meet all safety criteria of Report 350 Test Level 3, however, the analyses implied that the system's performance could be significantly enhanced if the wheel of the pickup truck could be prevented from pushing underneath the rail and/or prevent the wheel from contacting the guardrail posts. The analyses showed that the w-beam on the face of the standard GR-2.2 system is much less stiff than the tubular backup and as a result the tire of the pickup truck in Test 3-11 would compresses the lower part of the w-beam rail inward, wrapping the w-beam around the tube, consequently, the wheel pushed underneath the rail.

Several modifications to the GR-2.2 were critically evaluated and were shown to improve the performance of the system:

- 1) Two-tube tubular backup system
- 2) Rub-rail retrofit
- 3) Nested w-beam retrofit
- 4) Added tube through lower spacer block retrofit (*analysis not conducted*)

The foregoing analyses for Modification A (the staggered rail across the connection of the GR-2.2 guardrail with the modified GR-3.4 transition) provided information that suggests a simple retrofit alternative to the system would be to use *Nested W-Beam Rails on the GR-2.2* with an *unmodified GR-3.4* transition, as illustrated in Figure 48. This may be a more attractive solution since the GR-3.4 will be unmodified and thus will not have to be further evaluated to ensure that the transition from the GR-3.4 to a length-of-need guardrail (e.g., ODOT Type 5 guardrail) will perform safely (i.e., the GR-3.4 is already approved as a transition from a strong-post guardrail to the Texas T101 Bridge Rail).

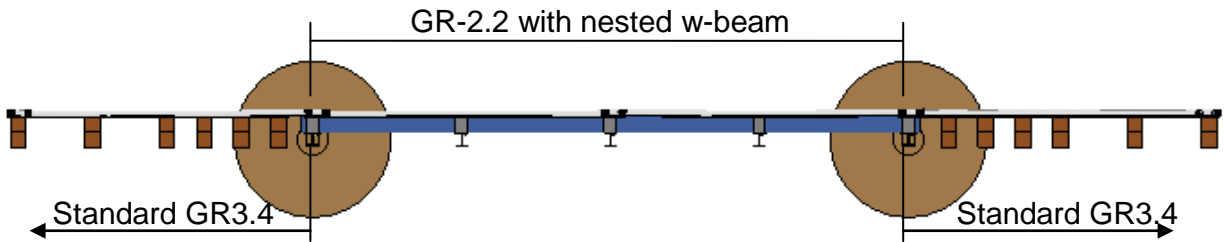

Figure 48: Modified GR-2.2 guardrail with nested w-beam rails and standard GR-3.4 transition.

The nested w-beam rails provide enough stiffness to prevent the tire of the truck from pushing underneath the rail and also provide a more consistent stiffness across the connection of the GR-2.2 to the GR-3.4 transition, as illustrated below in Figure 49.

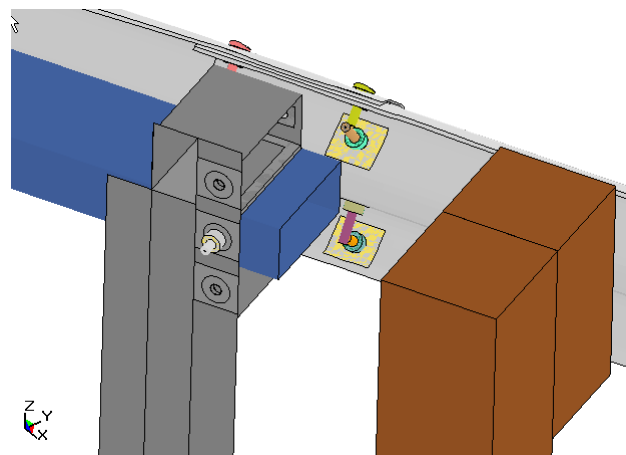

Figure 49: Modified GR-2.2 guardrail with nested w-beam rails and standard GR-3.4 transition.

One impact case was evaluated based on the worse-case scenario for the wheel pushing under the rail and corresponds to Case 6:

- Downstream impact on GR-2.2 approaching GR-3.4
 - Vehicle impacts 1.6 m upstream from transition connection
 - Modified GR-2.2 with nested rails
 - Posts in concrete
 - End posts in soil

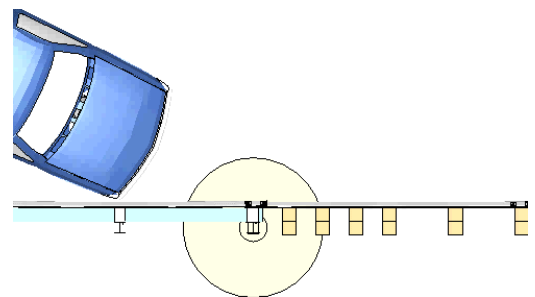
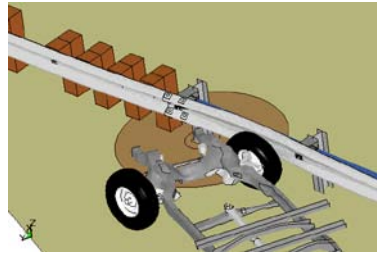
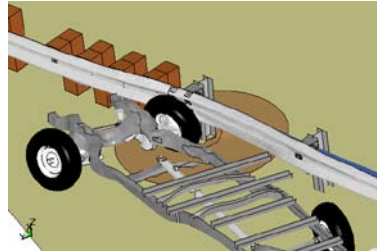
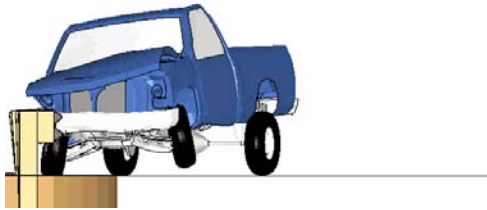

Figure 50 shows sequential views of the results of Modification B from a downstream view point and an overhead view perspective. The wheel of the pickup truck again was prevented from pushing underneath the rail and the system met all safety requirements of NCHRP Report 350 Test Level 3. A summary of Occupant risk measures were computed and are provided below in Table 19 and the acceleration-time histories are shown in Figure 51.

Time = 0.050 seconds



Time = seconds



Time = 0.150 seconds

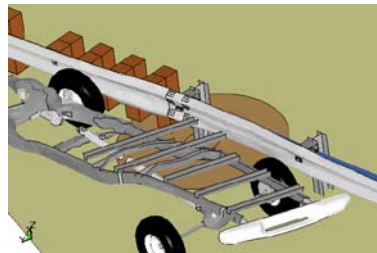
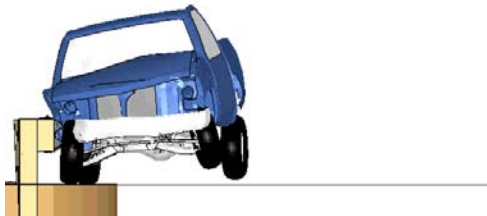

Time = 0.200 seconds

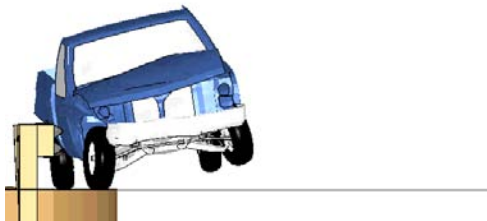

Time = 0.800 seconds



Figure 50: Sequential views of the NCHRP Report 350 Test 3-11 analysis of the modified GR-2.2 with nested w-beam rails and standard GR-3.4 transition for impact.

Table 19: Occupant risk values computed using the software TRAP for analysis of the modified GR-2.2 with nested w-beam rails and standard GR-3.4 transition

Occupant Risk Factors		
Impact Velocity (m/s)		at 0.0895 seconds on right side of interior
x-direction	5.6	
y-direction	8.1	
Ridedown Accelerations (g's)		
x-direction	-7.3	(0.0983 - 0.1083 seconds)
y-direction	-10.3	(0.2091 - 0.2191 seconds)
THIV (km/hr):	33.4	at 0.0876 seconds on right side of interior
THIV (m/s):	9.3	
PHD (g's):	12.3	(0.2090 - 0.2190 seconds)
ASI:	1.63	(0.0273 - 0.0773 seconds)

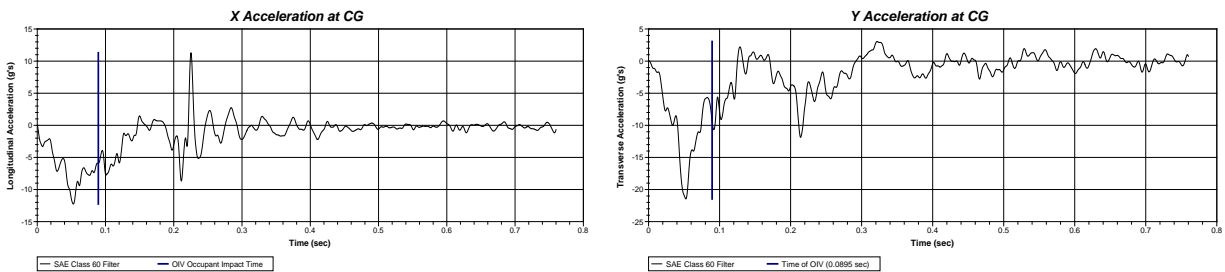

Figure 51: Acceleration-time histories computed at the c.g. of the vehicle for impact - NCHRP Report 350 Test 3-11 analysis of the modified GR-2.2 with nested w-beam rails and standard GR-3.4 transition

Phase II Summary

The analyses of the original system indicated that there was a stiffness discontinuity at the connection point of the ODOT GR-2.2 to the ODOT GR-3.4 that may lead to pocketing and wheel snag.

Two modifications to the GR-2.2 guardrail and GR-3.4 transition system were evaluated:

1. Modified connection with “staggered w-beam rails and
2. Modified GR-2.2 with nested w-beam rails

The analyses indicated that both design modifications would meet the safety criteria of NCHRP Report 350 Test Level 3. The modified GR-2.2 with nested w-beam rails was considered the

more practical option because it not only solved the problem with the connection of the GR-2.2 guardrail to the GR-3.4 transition, but also improves the performance of the GR-2.2 by preventing wheel snag on posts, as discussed in Phase I.

PHASE III – NCHRP REPORT 350 TL-3 QUALIFICATION OF FINAL GUARDRAIL DESIGNS

Phase 3 involved verification that the final guardrail and transition designs were TL-3 approved systems, and ultimately, to receive FHWA acceptance for the use of the systems on the National Highway System. Qualification for TL-3 is typically done through full-scale crash testing which was included in the original research approach; however, full-scale testing was not required by FHWA due to sufficient evidence of successful performance of the final system design demonstrated in the F.E. analysis.

The analysis results for the original design of the ODOT GR-2.2 guardrail were presented to the FHWA in a request for approval of the ODOT GR-2.2 as a TL-3 system. An approval letter was received from the FHWA in March 2005 qualifying the ODOT GR-2.2 as an NCHRP Report 350 Test Level 3 system for use on the National Highway System (NHS). The FHWA also acknowledged in the March 2005 acceptance letter that the proposed modifications would enhance the performance of the system under impact conditions that are more severe (i.e., higher speeds or steeper impact angles) than those required in NCHRP Report 350.

The Modified GR-2.2 with nested w-beam (i.e., Nested Type 5 Guardrail with Tubular Backup) and the standard ODOT GR-3.4 transition was presented to FHWA as an integrated system for TL-3 approval and an acceptance letter was received on August 10, 2005. It is the opinion of the research team that the Nested Type 5 Guardrail with Tubular Backup and the ODOT GR-3.4 are performance-matched and should be used as an integrated system until such time that another system is proven to be compatible.

PROJECT SUMMARY

EVALUATION OF ODOT GR-2.2 GUARDRAIL

Finite element analysis was used to evaluate the performance of the GR-2.2 guardrail system. It was not be feasible to evaluate every scenario of soil cover, post type and post mounting condition, thus two post mounting conditions were selected for evaluation in the analysis

- 1) Post completely encased in concrete
- 2) Posts embedded in 3'-5" of soil

These mounting conditions represent the most stiff and the most flexible boundary condition, respectively, for the system and were chosen because they bound the problem (i.e. the performance of the other mounting options should fall somewhere between these two scenarios).

The analyses indicated that the system would pass NCHRP Report 350 Test Level 3. A letter from the FHWA was received in March 2005 qualifying the ODOT GR-2.2 as an NCHRP Report 350 Test Level 3 system.

IMPROVEMENTS TO THE ODOT GR-2.2 GUARDRAIL

In addition to assessing the likelihood for the system to pass NCHRP Report 350 Test Level 3, the objectives of the study also included identifying weaknesses in the system and to propose design changes and retrofit alternatives that would enhance the performance of the system. The only weakness of the system identified in the F.E. analysis was a slight potential for wheel snag under extreme impact conditions. The F.E. analysis indicated that the system would pass Report 350 Test Level 3, but during impact, the impact-side front tire "grazed" one of the guardrail posts. Under Test 3-11 impact conditions the ODOT GR-2.2 should perform adequately, however, for more severe impact conditions, wheel snag becomes more likely and can easily be avoided with simple modifications to the system. Four modified systems were proposed to mitigate wheel snag and three of those were analyzed using F.E.A.:

- 1) A modified two-tube system (*analysis indicated successful performance*)
- 2) A rub-rail retrofit (*analysis indicated successful performance*)
- 3) Nested w-beam retrofit (*analysis indicated successful performance*)

4) Added tube through lower spacer block retrofit (*not analyzed*)

It was shown that these modifications would successfully prevent wheel contact with the guardrail posts and that the increase in stiffness of the modified systems would not adversely affect occupant risk measures.

EVALUATION OF THE COMPATIBILITY OF THE ODOT GR-3.4 TRANSITION

The transition system currently used with the ODOT GR-2.2 is the ODOT GR-3.4 transition system (ODOT Bridge Terminal Assembly Type 4), however, the ODOT GR-3.4 transition is not approved as a TL-3 system for general use as a transition to a rigid barrier. A drawing of the ODOT GR-3.4 transition system is shown in Appendix 1.

Most transition systems are used with rigid barriers, such as bridge rails and concrete median barriers, where the transition section is required to be very rigid as it nears the attachment point to the barrier. The ODOT GR-2.2 guardrail, on the other hand, has a range of stiffness values depending on the mounting conditions of the guardrail posts. Because of the relatively high lateral stiffness of the FHWA approved TL-3 transition systems (see list of approved systems on the FHWA website at http://safety.fhwa.dot.gov/roadway_dept/road_hardware/longbarriers.htm) it was decided by the research team that none would likely be compatible with the ODOT GR-2.2 guardrail. For example, in the case of a non-rigid mounting condition of the ODOT GR-2.2 (e.g., posts embedded in soil), the ODOT GR-2.2 could be less stiff than the transition section which may result snagging at the connection point of the two systems caused by excessive deflection of the guardrail in relation to the transition. Thus, a critical impact scenario that had to be considered was an impact on the ODOT GR-2.2 at a point upstream of the connection to the transition system. It was expected that the GR-3.4 transition system would be the most promising candidate for use with the ODOT GR-2.2 guardrail because it is not as stiff the standard TL-3 transition systems which are designed for use with rigid barriers.

Several finite element analyses were performed to evaluate the crash performance of the ODOT GR-3.4 transition and ODOT GR-2.2 guardrail combination under Report 350 Test 3-11 conditions:

- 1) GR-2.2 with **posts in soil**. Impact on transition at approximately **1.5 m** upstream of barrier
- 2) GR-2.2 with **posts “fixed” at ground line (concrete encased)**. Impact on transition at approximately **1.5 m** upstream of barrier
- 3) (a) GR-2.2 with **posts in “weak” soil**. Impact on GR-2.2 at approximately **1.5 m** upstream of transition
 (b) GR-2.2 with **posts in “standard” soil**. Impact on GR-2.2 at approximately **1.5 m** upstream of transition
- 4) (*Analysis not conducted*) - GR-2.2 with **end-posts in soil, center posts “fixed” at ground line (concrete encased)**. Impact on Transition at approximately **1.5 m** upstream of transition
- 5) GR-2.2 with **end-posts in soil, center posts “fixed” at ground line (concrete encased)**. Impact on Transition at approximately **1.5 m** upstream of the GR-2.2.
- 6) GR-2.2 with **end-posts in soil, center posts “fixed” at ground line (concrete encased)**. Impact on GR-2.2 at approximately **1.5 m** upstream of transition

The analyses indicated that the system would likely pass Report 350 Test 3-11, however, slight wheel snags did occur at the connection point of the transition in cases where the impact point was on the GR-2.2 at 1.5 m upstream of the transition (i.e., cases 3 and 6). In those two cases the ridedown accelerations were computed to be 18.2 g and 15.6 g, respectively. The problem was identified to be a *stiffness discontinuity* at the w-beam rail *connection* of the GR-2.2 and the GR-3.4 transition, which resulted in the wheel pushing under the rail and then snagging at the connection point of the transition to the guardrail.

The solution to the problem was to equalize the stiffness of the w-beam rails across the splice connection without significantly increasing the stiffness of the GR-2.2. After evaluating various options, the most practical and cost effective retrofit to the system was determined to be a modified ODOT GR-2.2 guardrail with nested w-beam rails, as shown in Figure 55.

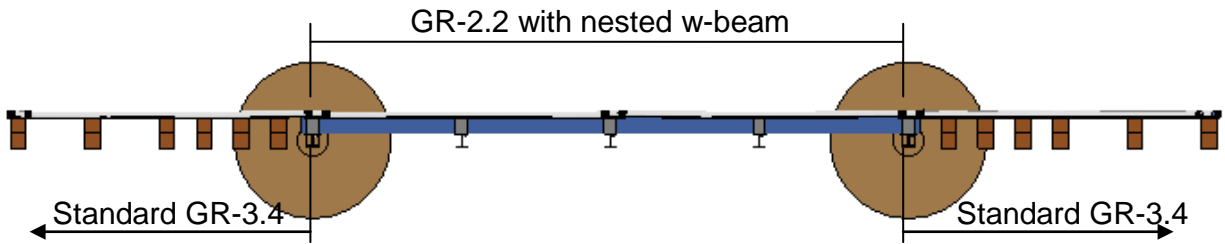

Figure 52: Modified ODOT GR-2.2 guardrail with nested w-beam rails and standard ODOT GR-3.4 transition.

The nested w-beam rails provided enough stiffness to prevent the tire of the truck from pushing underneath the rail and also provided a more consistent stiffness across the connection of the GR-2.2 to the GR-3.4 transition, resulting in more than 40% reduction in maximum ridedown accelerations compared to the original system.

CONCLUSIONS AND RECOMMENDATIONS

Based on the results of this study, the original design of the ODOT GR-2.2 guardrail and all the proposed modifications satisfy performance requirements of NCHRP Report 350 Test level 3. Both the original ODOT GR-2.2 guardrail design and the modified ODOT GR-2.2 with nested w-beams were approved by the FHWA as NCHRP Report 350 TL-3 systems and may be used on the National Highway System at the state's discretion.

The integrated system of the Nested Type 5 Guardrail with Tubular Backup and the ODOT GR-3.4 transition provides significantly improved performance over the original design. It is also considered the most practical and feasible design improvement and is therefore recommended as a final design.

IMPLEMENTATION PLAN

Based on the results of this study, the original design of the ODOT GR-2.2 has been accepted by the FHWA as a TL-3 guardrail. This design is currently installed over many culverts throughout Ohio, and since it is now considered a TL-3 system, it need only be repaired when damaged. It is suggested, however, that the repair also include a retrofit to the system including a nested w-beam rail on the ODOT GR-2.2 (i.e., upgrade the system to the Nested Type 5 Guardrail with Tubular Backup) so that crash performance will be enhanced.

Drawings of the Nested Type 5 Guardrail with Tubular Backup were provided to ODOT's Standards Engineer, Dean Focke. Based on these drawings and the research results, ODOT has revised their standard construction drawings of the ODOT GR-2.2 guardrail and the ODOT GR-3.4 transition to reflect modifications that were made to these systems.

Implementation of the Nested Type 5 Guardrail with Tubular Backup should flow smoothly since minimum hardware change is needed. In fact, the retrofit system does not include any additional part numbers.

REFERENCES

-
- ¹ Chief, Federal Aid and Design Division, "Crash Testing of Bridge Railings," Memorandum to Regional Administrators, http://safety.fhwa.dot.gov/roadway_dept/road hardware/bridgerailings.htm, May 30, 1997.
- ² Bronstad, M.E., J.D. Michie, L.R. Calcote, K.L. Hancock, and J.B. Mayer, "Bridge Rail Designs and Performance Standards, Volume I: Research Report," Report No. FHWA/RD-87/049, Submitted to the Safety Design Division, Federal Highway Administration, Performed by Southwest Research Institute, February 1987.
- ³ Tiso, P., Plaxico, C.A. and Ray, M.H., "An Improved Truck Model for Roadside Safety Simulations: Part II - Suspension Modeling," Transportation Research Record (in press), Transportation Research Board, Washington, D.C., 2002.
- ⁴ Tiso, P., "Improvements to the Suspension of the NCAC C2500 Pickup Truck Finite Element Model," Master's Thesis, Worcester Polytechnic institute, Worcester, MA, 2001.
- ⁵ Plaxico, C.A., Design Guidelines for the Use of Curbs and Curb/Guardrail Combinations along High-Speed Roadways, Ph.D. Dissertation, Worcester Polytechnic Institute, Worcester, MA, 2002.
- ⁶ Kennedy, J.C, Jr., C.A. Plaxico and C.R. Miele, "Design, Development and Qualification of a New Guardrail Post," Paper in review, Transportation Research Board, Washington, D.C., 2006.
- ⁷ Jewell, John, Payam Rowhani, Roger Stoughton and William Crozier, "Vehicular Crash Tests of a Slip-formed, Single Slope, Concrete Median Barrier with Integral Concrete Glare Screen," Material Engineering and Testing Services, Final Report, Report No. 636057, September 1997.